

# PRODUCT CATALOGUE 2025



 **Stoeger** AIRGUNS

 **BERETTA**  
HOLDING

 BERETTA

 **Benelli**

FRANCHI

 **Stoeger**

 Uberti

**sako**

 *Burris*

**STEINER** 

 **TIKKA**

**I&H**

 **CHAPUIS ARMES**  
FRANCE

 **Stoeger AIRGUNS**

*Rottweil*

**norma**  
DEDICATED SINCE 1908

SWISS 

 **Geco**

 **MFS**  
SINCE 1932

 **RWS**  
SINCE 1886

**Stoeger AIRGUNS**  
is the Brand launched in 2008  
by the prestigious industrial **BERETTA HOLDING**

on the international airgun market,  
a new niche for the company,  
using synergy of Italian Engineering and Design,  
Beretta Group experience in the hunting,  
shooting and optic industries, production  
plants and own Beretta distribution forces.  
A team of italian designers and  
engineers are permanently  
developing new products.

**Stoeger AIRGUNS**  
is the exclusive  
**BERETTA HOLDING**  
Brand in the field  
of compressed  
air shooting.





## STOEGER AIRGUNS MISSION

Stoeger AIRGUNS mission is to offer innovative design, advanced ergonomics, fascinating models with excellent ballistic performance at the right price. Our vision is permanent innovation and development of new airgun lines motivating young people to approach the world of hunting and shooting in training by handling air guns and start to develop a proper shooting technique.

## DESIGN AND PRODUCT DEVELOPMENT

Innovation in design is the brand's rooted pillar in our ability to understand consumer needs, tastes and aspirations. Italian designers and engineers are constantly engaged to create new possible models where stylistic innovation is combined with functionality. Determined proportions, clear contours, precise lines and pure surfaces are characteristics of Stoeger AIRGUNS design. Design is the focal point where vision, creative inspiration and technology converge. At every phase of the process, from design to industrialization, Stoeger AIRGUNS performs rigorously and tests the quality with precision.



### INNOVATION AS A MUST

Stoeger AIRGUNS is synonymous with Innovation and Italian Design. The Airguns are exclusive, sensual, provocative and always unmistakably Italian. In fact, all our models are entirely idealized and designed in Italy. Stoeger AIRGUNS has always been the creator of dynamic and unrivalled rifles.



### SPORTING HEART

Stoeger AIRGUNS rifles are recreational air rifles to have fun, to enjoy the first experience of hunting and shooting. Enjoy the nature, feel good and take up a different air rifle. Our rifles are incomparable through their blend of Fascinating Design and Supreme Shooting Ergonomics.



### OUR PHILOSOPHY

Stoeger AIRGUNS has always in mind the design and implementation of something special that could convey new emotions to the shooters. The Stoeger AIRGUNS brand has a cutting-edge, distinct and streamlined design with multiple souls: Sporty, Elegant and Innovative.

DESIGNED IN ITALY



**HUMAN TECH DESIGN**

With its new Lines, Stoeger AIRGUNS creates the first compressed air rifles inspired by Urbino in Italy, a world heritage city, the cradle of Humanism. Stoeger AIRGUNS combines Urbino's technical inspiration with the innovative vision of Milan's designers whose experience in Industrial Design (ID) and User Experience (UX) is able to transform their technical inspirations into solid and attractive projects. Just thanks to this combination, Stoeger AIRGUNS creates a new method, based on 3 sound compact concepts: Functional Ergonomics, User Interaction Study, User Experience.



**PRO ADAPTIVE CHECKERING**

Stoeger AIRGUNS Pro Adaptive Checkering is the first technical result of our new "Human Tech Design" philosophy. It is the most versatile, efficient and progressive checkering developed so far, one of a kind. It is the result of a project which let shooters expose themselves to a new experience, become one with the airgun and find a perfect feeling with it. The special checkering progression actively and comfortably "fits" the gun, no matter the environment shooters find themselves in.



**MULTI GRIP SYSTEM**

Stoeger AIRGUNS offers a shooter the choice of the favourite grip and comfort thanks to the new Multi Grip System technology which, by means of an easy and intelligent system, let the rifle be customized. Finally, shooters can adapt the rifle to their own style. Stoeger AIRGUNS rifles are incomparable through their blend of: Fascinating Design, Supreme Shooting Ergonomics, Innovative Style, Technological Capability and Quality.



**BEST ACCURACY**

Stoeger AIRGUNS XM1 PCP rifles high precision and best accuracy: every Stoeger AIRGUNS XM1 PCP rifle is accuracy-tested to certify your rifle can perform the best accuracy in its category with a 5 shot group. Ammunition used: Stoeger AIRGUNS X-Sport / Stoeger AIRGUNS X-Match; Distance: 10 m; Power of the rifle: Full Power; N° of shots: 5.



**XM1 SPORT ADVANCED ACCURACY**

The Italian design of the SPORT muzzle brake allow the rifle to be more accurate on target by reducing the turbulence behind the pellets, in order to meet the competition shooter needs.



**XM1 SPORT MATCH TRIGGER**

The XM1 SPORT match trigger allows the shooter to find the best comfort trigger position in order to achieve the best target acquisition. The length of pull (max. range of 20 mm), inclination and rotation are all fully adjustable. Thanks to the numerous adjustments, the whole trigger action is fluid, soft, light and instantaneous.



**FREE FLOATING BARREL**

The Free-Floating Barrel system represents a cutting-edge design in the world of air-shooting, particularly in precision shooting. This system redefines how an Airguns barrel is positioned and supported within the Airguns frame. The Free-Floating Barrel system allows the barrel to "float" independently within the Airguns frame. This means that the barrel is not in direct contact with the stock or frame. This innovative technical design has a profound impact on accuracy. This enhanced stability and consistency are fundamental to achieving pinpoint accuracy in air-shooting, where even slight variations in the barrel's position or vibration can make a significant difference in where the shot lands.

\*S3 Suppressor Patented: EP3023729, US10514224, ZL201580063122.8  
 \*\*S4 Suppressor Patented: EP3023729, US10514224, ZL201580063122.8



**ADJUSTABLE TRIGGER**

The adjustable trigger feature is designed to provide shooters with the ability to customize their shooting experience to achieve the highest levels of accuracy and comfort. This feature allows the shooter to finely adjust the trigger's pull weight, offering a range from 600 grams to 350 grams. By being able to modify the trigger's pull weight, shooters can find the perfect balance that suits their individual preferences. In essence, this adjustable trigger system empowers shooters to fine-tune their rifle's trigger to match their specific shooting style and requirements, whether that's optimized precision or a more relaxed and comfortable shooting experience.



**ADJUSTABLE HAMMER SPRING**

The hammer spring adjustment empowers shooters to fine-tune the hammer's opening, enabling precise control over the rifle's power output based on the type and shape of pellets used. Another important technological plus that makes Stoeger AIRGUNS rifles increasingly precise, reliable and versatile in every type of use, in hunting small and medium game, in precision sports shooting and in long-distance performance.



**S3 SUPPRESSOR PATENTED\***

Completely developed from scratch, it is the first suppressor in the world to have an interchangeable front sight and an air decompression chamber that further enhances the performance of the air regulation baffles, optimized to be more performing than the S2 version. The revolutionary design of the S3 Suppressor has made it possible to develop a longer barrel (35 mm), hence with a greater precision of shooting.



**S4 SUPPRESSOR PATENTED\*\***

The latest Stoeger AIRGUNS design evolution of the integral silencer system. It combines the Dual-Effect of the baffles and decompression chamber and now the additional compensator technology. The most advanced technology to reduce the noise better than ever. The best in its class.



**RX LINE**

The RX Line has been developed having in mind a new challenge: the design and implementation of something special that could convey new emotions to both the enthusiastic shooters and those who just want to have fun in the open air or at the shooting range. The RX Line represents the perfect match between technological style, technical efficiency and care for details. The elegant and ergonomic shapes makes the gun fit perfectly to the shooter. Stoeger AIRGUNS and its RX Line translate technology in style.



**XM1 LINE**

The PCP XM1 Line ensures the best performance in every shooting situation, thanks to the ergo/anatomical studies performed by Italian Engineers (Human Tech Design) and the best weight-stability ratio of the rifle. XM1 has a cutting-edge, distinct and streamlined design with multiple souls: sporty, elegant and innovative. A distinct style of Stoeger AIRGUNS coupled with traits of a sports rifle and hunting rifle. XM1 provides to the shooter a uniquely emotional experience. With its strong personality, pure design and absolute sportiness, PCP XM1 Line is one of a kind.



**XRD LINE**

The first handgun powered by a CO2 technology branded Stoeger Airguns. Introducing the all-new powered by CO2 technology with 12-gram cartridges, the XRD50 is easy to use and incredibly fun. Designed specifically for training engagements, shooting practice, and domestic self-defense, the XRD50 showcases Stoeger Airguns' dedication to innovation.

**XRD50**



**TRAINING  
AND FUN**

 **Stoeger** AIRGUNS

 **BERETTA**  
HOLDING

12,7 mm/.50: 100 m/s - 330 fps | 131 m/s - 430 fps

## XRD50

Introducing the all-new Powered by CO2 technology with 12-gram cartridges, the XRD50 is easy to use and incredibly fun. Designed specifically for training engagements, shooting practice and domestic use, the XRD50 showcases Stoeger Airguns' dedication to innovation.



PAINTBALL



PLINKING



TRAINING FOR  
ENGAGEMENT



AMMUNITION MAGS

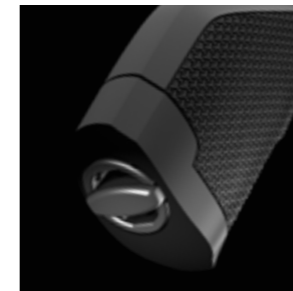

CO2 CHAMBER CAP

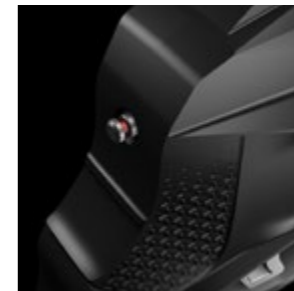

PRESSURE INDICATOR PIN (PIP)



MUZZLE BRAKE

## XRD50 - TECHNICAL FEATURES

Power Source CO2	< 7,5 J	< 12,7 J
Caliber	12,7 mm/.50	12,7 mm/.50
Height	176mm	176mm
Length	307mm	307mm
Width	41mm	41mm
Weight	700g ca.	700g ca.
Barrel	138mm	138mm
Max Pressure	6Mpa	6Mpa
Velocity	330FPS	430FPS

# XM1 PCP LINE



XM1 Ranger



XM1 Ranger Carbon



XM1 Scout



XM1 Scout Carbon



XM1 Bullpup



XM1 Bullpup Carbon



XM1



XM1 Sport



XM1 Sport Suppressor



XM1 Suppressor



 **Stoeger** AIRGUNS

 **BERETTA**  
HOLDING

**XM1** RANGER

**XM1** SCOUT



**THE FEARLESS  
RIFLES**

 **Stoeger** AIRGUNS

 **BERETTA**  
HOLDING





**01 Comfort rear pad**  
To provide the best comfort and stability to the shooter

**02 Two spacers to adapt the LOP**  
To the shooter needs, LOP 355 mm max. (med.= 349 mm, min.= 343 mm)

**03 Adjustable comb**  
5 different position (from 0 to +30 mm) to find your best comfort and adapt the rifle to any kind of scopes and shooters

**04 Improved ergonomics**  
The advanced stock design provide multiple grip and shooting position

**05 Interchangeable pistol grip**  
Two different size of pistol grip to provide the best comfort and ergonomics to the shooters

**06 Ultimate Thumbhole stock design**  
For a perfect ergonomics and comfort

**07 Adjustable hammer spring**  
To provide the best power regulation according with the type of pellets used

**08 Straight-pull loading system**  
To provide smooth and fast reload

**09 Adjustable trigger pull**  
From 700 g to 400 g to achieve the maximum accuracy on target and the best comfort

**10 Integrated picatinny rail**  
To provide solid and accurate scope mount

**11 Hi-Capacity Magazine**  
12 rounds in 4,5 mm; 10 rounds in 5,5 mm; 9 rounds in 6,35 mm

**12 Aluminum receiver**  
Lightweight and robust, with strong black matte anodized finishing

**13 Decompression chamber and holes**  
To minimize the air turbulence at the muzzle

**14 Air regulator gauge**  
To check the exact moment to refill the air tank

**15 Barrel lengths: XM1 Ranger 600 mm, XM1 Scout 450 mm**  
Free floating and extra long barrel to provide maximum power and accuracy

**16 Threaded muzzle**  
½" UNF thread to fit various muzzle devices

**17 Three picatinny rails**  
To give at the user the possibility to fit any kind of bipods and accessories

**18 Flat style varmint forend**  
To provide max stability on bench rest

**19 Air tank**  
XM1 Ranger 300 cc - 250 bar  
XM1 Scout 200 cc - 250 bar  
High air capacity to provide a longer shooting of session before refill

**20 Air tank gauge**  
To accurate check the air tank pressure

4,5 mm/.177: 310 m/s - 1020 fps 5,5 mm/.22: 270 m/s - 890 fps 6,35 mm/.25: 265 m/s - 870 fps

## XM1 RANGER

The constant quest for improvement has led Stoeger AIRGUNS to develop two new rifles, the XM1 RANGER and the XM1 SCOUT, expanding the range of the XM1 line, offering ideal solutions for small and medium game hunting, as well as long-range and precision shooting.



## INCLUDED WITH THE RIFLE



**PRO ADAPTIVE LENGTH**  
Length of pull adjustable with spacers for optimal comfort



**ADJUSTABLE COMB**  
5 different position (from 0 to +30 mm) to find the best comfort and adapt the rifle to any kind of scopes and shooters

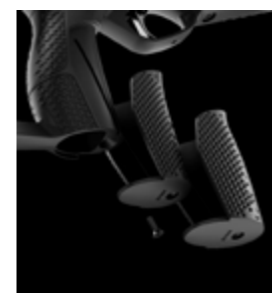

**INTERCHANGEABLE PISTOL GRIP**  
Two different size of pistol grip to provide the best comfort and ergonomics to the shooters



**STRAIGHT-PULL LOADING SYSTEM**  
To provide smooth and fast reload



**THREE PICATINNY RAILS**  
To give at the user the possibility to fit any kind of bipods and accessories



**ADJUSTABLE HAMMER SPRING**  
To provide the best power regulation according with the type of pellets used



**ADJUSTABLE TRIGGER**  
From 700 g to 400 g to achieve the maximum accuracy on target and the best comfort

## XM1 RANGER - TECHNICAL FEATURES

<b>Caliber</b>	4,5 mm /.177 - 5,5 mm /.22 - 6,35 mm /.25	<b>Weight (+/- 0,1)</b>	3,55 Kg
<b>Power source</b>	Precharged pneumatic (PCP) with integrated regulator	<b>Velocity cal. 4,5 mm (+/- 2%) 0,69 g pellet</b>	Up to 310 m/s - 1020 fps
<b>Cocking system</b>	Straight Pull	<b>Velocity cal. 5,5 mm (+/- 2%) 1,37 g pellet</b>	Up to 270 m/s - 890 fps
<b>Trigger System</b>	Two stage trigger - Three lever Adjustable from 0,7 to 0,4 Kg (factory preset 0,7 Kg)	<b>Velocity cal. 6,35 mm (+/- 2%) 2 g pellet</b>	Up to 265 m/s - 870 fps
<b>Safety</b>	Manual on trigger	<b>Max energy delivered (+/- 2%)</b>	Cal. 4,5 mm / .177: 33J - Cal. 5,5 mm / .22: 50J - Cal. 6,35 mm / .25: 70J
<b>Sight / Scope Rail</b>	No sight - Picatinny rail machined on the receiver	<b>Cylinder Pressure</b>	250 BAR / 3630 PSI fill pressure / Integrated pressure gauge + Integrated pressure gauge for air regulator check
<b>Stock</b>	Human Tech Design Synt. Stock - Ergonomic Features - MGS Technology Ambidextrous Stock Design - Adjustable 5 positions comb	<b>Cylinder Size</b>	300cc
<b>Finish</b>	Black Synthetic stock - Black anodized receiver and air cylinder	<b>Rotary magazine</b>	12 shots magazine in cal. 4,5 mm /.177 - 10 shots magazine in cal. 5,5 mm /.22 9 shots magazine in cal. 6,35 mm /.25
<b>Total length</b>	1097 mm / 43.2"	<b>Included in the box</b>	Charging connector, 2 magazines, 3 side rails, MGS kit, instruction manual, spare O-rings
<b>Barrel</b>	600 mm - Free floating - Rifled, blued steel barrel with black anodized barrel cover and integrated air decompression chamber - Twist rate (mm) 1:480 - Muzzle thread 1/2" UNF	<b>Suggested for</b>	Medium game hunting / Small game hunting / Varmint control / Target shooting



**THE STOEGER AIRGUNS XM1 SCOUT HAS BEEN AWARDED BY THE PRESTIGIOUS GUNS & AMMO AS AIR GUN OF THE YEAR 2024**

This year's innovation was the introduction of the air gun category, in which the PCP XM1 SCOUT rifle fully met the requirements set by the Outdoor Sportsman Group (OSG) in Grand Junction, Colorado. Only the most innovative and cutting-edge products available in 2024 were selected and evaluated by the Guns & Ammo staff to determine the best product of the year. The voting concluded with the awarding of the AIR GUN OF THE YEAR award to the XM1 SCOUT model from Stoeger AIRGUNS.

The rifle was awarded in terms of excellence: build quality, material quality, and technological innovation. All factors that contribute to ballistic performance at a very high level. The unmistakable know-how of Stoeger AIRGUNS in the field of air rifles is combined with a constant process of design and research, generating innovative solutions while also paying attention to style and design, completely made in Italy.



**4,5 mm/.177:** 295 m/s - 965 fps **5,5 mm/.22:** 255 m/s - 840 fps **6,35 mm/.25:** 245 m/s - 805 fps

## XM1 SCOUT

The constant quest for improvement has led Stoeger AIRGUNS to develop two new rifles, the XM1 RANGER and the XM1 SCOUT, expanding the range of the XM1 line, offering ideal solutions for small and medium game hunting, as well as long-range and precision shooting.



### INCLUDED WITH THE RIFLE



**PRO ADAPTIVE LENGTH**  
Length of pull adjustable with spacers for optimal comfort



**ADJUSTABLE COMB**  
5 different position (from 0 to +30 mm) to find the best comfort and adapt the rifle to any kind of scopes and shooters

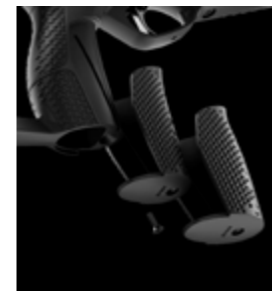

**INTERCHANGEABLE PISTOL GRIP**  
Two different size of pistol grip to provide the best comfort and ergonomics to the shooters



**STRAIGHT-PULL LOADING SYSTEM**  
To provide smooth and fast reload



**THREE PICATINNY RAILS**  
To give at the user the possibility to fit any kind of bipods and accessories



**ADJUSTABLE HAMMER SPRING**  
To provide the best power regulation according with the type of pellets used



**ADJUSTABLE TRIGGER**  
From 700 g to 400 g to achieve the maximum accuracy on target and the best comfort

### XM1 SCOUT - TECHNICAL FEATURES

<b>Caliber</b>	4,5 mm /.177 - 5,5 mm /.22 - 6,35 mm /.25	<b>Weight (+/- 0,1)</b>	3,3 Kg
<b>Power source</b>	Precharged pneumatic (PCP) with integrated regulator	<b>Velocity cal. 4,5 mm (+/- 2%) 0,69 g pellet</b>	Up to 295 m/s - 965 fps
<b>Cocking system</b>	Straight Pull	<b>Velocity cal. 5,5 mm (+/- 2%) 1,37 g pellet</b>	Up to 255 m/s - 840 fps
<b>Trigger System</b>	Two stage trigger - Three lever Adjustable from 0,7 to 0,4 Kg (factory preset 0,7 Kg)	<b>Velocity cal. 6,35 mm (+/- 2%) 2 g pellet</b>	Up to 245 m/s - 805 fps
<b>Safety</b>	Manual on trigger	<b>Max energy delivered (+/- 2%)</b>	Cal. 4,5 mm / .177: 30J - Cal. 5,5 mm / .22: 44J - Cal. 6,35 mm / .25: 60J
<b>Sight / Scope Rail</b>	No sight - Picatinny rail machined on the receiver	<b>Cylinder Pressure</b>	250 BAR / 3630 PSI fill pressure / Integrated pressure gauge + Integrated pressure gauge for air regulator check
<b>Stock</b>	Human Tech Design Synt. Stock - Ergonomic Features - MGS Technology Ambidextrous Stock Design - Adjustable 5 positions comb	<b>Cylinder Size</b>	200cc
<b>Finish</b>	Black Synthetic stock - Black anodized receiver and air cylinder	<b>Rotary magazine</b>	12 shots magazine in cal. 4,5 mm /.177 - 10 shots magazine in cal. 5,5 mm /.22 9 shots magazine in cal. 6,35 mm /.25
<b>Total length</b>	957 mm / 37.7"	<b>Included in the box</b>	Charging connector, 2 magazines, 3 side rails, MGS kit, instruction manual, spare O-rings
<b>Barrel</b>	460 mm - Free floating - Rifled, blued steel barrel with black anodized barrel cover and integrated air decompression chamber - Twist rate (mm) 1:480 - Muzzle thread 1/2" UNF	<b>Suggested for</b>	Medium game hunting / Small game hunting / Varmint control / Target shooting



- 01 Interchangeable cheekpiece**  
Two comb size available to provide the best comfort to the shooter
- 02 Mag position**
- 03 Bullpup System**
- 04 Comfort rear pad**  
To provide the best comfort and stability to the shooter

- 05 Two spacers to adapt the LOP**  
To the shooter needs, LOP 355 mm max. (med.= 349 mm, min.= 343 mm)
- 06 Improved ergonomics**  
The advanced stock design provide multiple grip and shooting position
- 07 Barrel**  
490 mm barrel length
- 08 Picatinny rail**
- 09 Straight-pull loading system**  
To provide smooth and fast reload

- 10 Decompression chamber and holes**  
To minimize the air turbulence at the muzzle
- 11 Trigger group**  
Two stage trigger
- 12 Interchangeable pistol grip**  
Two different size of pistol grip to provide the best comfort and ergonomics to the shooters
- 13 Integrated compensator**  
To minimize the turbulence beyond the pellets and to be more accurate on target

- 14 Picatinny**  
With mag rack
- 15 Air tank**  
265 cc air volume tank  
250 bar max pressure
- 16 Hi-Capacity Magazine**  
11 rounds in 4,5 mm; 9 rounds in 5,5 mm;  
8 rounds in 6,35 mm
- 17 Ergonomic front handle grip**  
To be more comfortable during the shooting



4,5 mm/.177: 285 m/s - 935 fps 5,5 mm/.22: 240 m/s - 780 fps 6,35 mm/.25: 230 m/s - 755 fps

## XM1 BULLPUP

The XM1 Bullpup is recognizable from its exclusive and innovative design developed in Italy from the very best expertise on the design. Inspired by the best in class automotive industries, the Stoeger AIRGUNS designers are constantly engaged on the development of new lines. The care on the details on design defines best in class ergonomics stock, offering better comfort and better accuracy. Ergonomic cocking lever position for a faster second target acquisition.



XM1 BULLPUP CARBON



XM1 BULLPUP

## INCLUDED WITH THE RIFLE



**MULTI GRIP SYSTEM**  
Ergonomic Front Handle



**CHEEKPIECE**  
Base - Raised



**PRO ADAPTIVE LENGTH**  
Length of pull adjustable with color spacers for optimal comfort



**ERGONOMIC BOLT LEVER**  
With exclusive THRIDION checkering for maximum grip



**MULTI GRIP SYSTEM**  
Pistol grip: Base blue - XL black

## XM1 BULLPUP - TECHNICAL FEATURES

<b>Caliber</b>	4,5 mm /.177 - 5,5 mm /.22 - 6,35 mm /.25	<b>Weight (+/- 0,1)</b>	2,8 Kg
<b>Power source</b>	Precharged pneumatic (PCP) with integrated regulator	<b>Velocity cal. 4,5 mm (+/- 2%) 0,69 g pellet</b>	Up to 285 m/s - 935 fps
<b>Cocking system</b>	Straight Pull	<b>Velocity cal. 5,5 mm (+/- 2%) 1,37 g pellet</b>	Up to 240 m/s - 780 fps
<b>Trigger System</b>	Two stage trigger	<b>Velocity cal. 6,35 mm (+/- 2%) 2 g pellet</b>	Up to 230 m/s - 755 fps
<b>Safety</b>	Manual on trigger	<b>Max energy delivered (+/- 2%)</b>	Cal. 4,5 mm / .177: 28J - Cal. 5,5 mm / .22: 40J - Cal. 6,35 mm / .25: 52J
<b>Sight / Scope Rail</b>	No sight - Picatinny rail	<b>Cylinder Pressure</b>	250 BAR / 3630 PSI fill pressure / Integrated pressure gauge
<b>Stock</b>	Human Tech Design Synt. Stock - Ergonomic Features - MGS Technology Ambidextrous Stock Design - 2 interchangeable combs	<b>Cylinder Size</b>	265cc
<b>Finish</b>	Black Synthetic stock - Black anodized receiver and air cylinder	<b>Rotary magazine</b>	11 shots magazine in cal. 4,5 mm /.177 - 9 shots magazine in cal. 5,5 mm /.22 8 shots magazine in cal. 6,35 mm /.25
<b>Total length</b>	700 mm / 27.5"	<b>Included in the box</b>	Charging connector, 2 magazines, 2 side rails, MGS kit, instruction manual, spare O-rings
<b>Barrel</b>	490 mm - Rifled, blued steel barrel with black anodized barrel cover and integrated air decompression chamber Twist rate (mm) 1:480 - Muzzle thread 1/2" UNF	<b>Suggested for</b>	Medium game hunting / Small game hunting / Varmint control / Target shooting



**01 Interchangeable cheekpiece**  
Monte Carlo for scope

**02 Interchangeable cheekpiece**  
Base for open sight

**03 Comfort rear pad**  
To provide the best comfort and stability to the shooter

**04 Two spacers to adapt the LOP**  
To the shooter needs, LOP 355 mm max. (med.= 349 mm, min.= 343 mm)

**05 Improved ergonomics**  
The advanced stock design provide multiple grip and shooting position

**06 Hi-Capacity Magazine**  
9 rounds in 4,5 mm ; 7 rounds in 5,5 mm

**07 Interchangeable pistol grip**  
Blue base

**08 Interchangeable pistol grip**  
Black XL

**09 Pro Adaptive Trigger**  
Most flexible trigger in its category, the first to offer the progressive regulation of the trigger length (-4 mm +8 mm) to provide smooth and fast reload

**10 Thridion Pro Adaptive Checkering EBL system**  
Ergonomic Bolt Lever is the first lever with exclusive Thridion checkering for maximum grip

**11 Anti-reflection angle rear sight**

**12 Air regulator integrated**

**13 Left side picatinny rail**  
With integrated rotary magazine rack and locking magnets. The first revolutionary multi-use picatinny rail developed by the Italian Engineers integrating a rack for 3 spare magazines

4,5 mm/.177: 280 m/s - 920 fps 5,5 mm/.22: 220 m/s - 720 fps

**XM1**

XM1 ensures the best performance in every shooting situation, thanks to the ergo/anatomical studies performed by Italian Engineers (Human Tech Design) and the best weight-stability ratio of the rifle.



**INCLUDED WITH THE RIFLE**

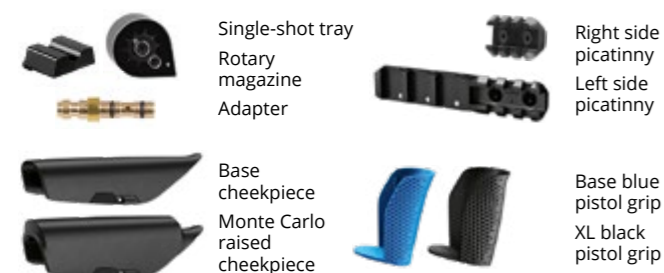

**PRO ADAPTIVE LENGTH**  
Length of pull adjustable with color spacers for optimal comfort



**ERGONOMIC BOLT LEVER**  
With exclusive THRIDION checkering for maximum grip



**LEFT SIDE PICATINNY RAIL**  
Multi-use Picatinny rail integrating a rack for 3 spare magazines



**PRO ADAPTIVE TRIGGER**  
Progressive regulation of the trigger length (-4 mm +8 mm)

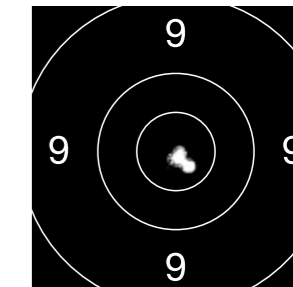

**HIGH PRECISION**  
XM1 PCP rifle can perform the best accuracy in its category with a 5 shot group

**XM1 - TECHNICAL FEATURES**

<b>Caliber</b>	4,5 mm /.177 - 5,5 mm /.22	<b>Weight (+/- 0,1)</b>	2,5 Kg
<b>Power source</b>	Precharged pneumatic (PCP) with integrated regulator	<b>Velocity cal. 4,5 mm (+/- 2%) 0,69 g pellet</b>	Up to 280 m/s - 920 fps
<b>Cocking system</b>	Bolt Action	<b>Velocity cal. 5,5 mm (+/- 2%) 1,37 g pellet</b>	Up to 220 m/s - 720 fps
<b>Trigger System</b>	Single stage trigger - Adjustable slide trigger (-4mm/+8mm)	<b>Max energy delivered (+/- 2%)</b>	Cal. 4,5 mm / .177: 27J - Cal. 5,5 mm / .22: 34J
<b>Safety</b>	Manual on trigger guard	<b>Cylinder Pressure</b>	200 BAR / 2900 PSI fill pressure / Integrated pressure gauge
<b>Sight / Scope Rail</b>	Adjustable sight - 11 mm dovetail	<b>Cylinder Size</b>	100cc
<b>Stock</b>	Human Tech Design Synt. Stock - Ergonomic Features - MGS Technology Ambidextrous Stock Design - 2 interchangeable combs	<b>Rotary magazine</b>	9 shots magazine in cal. 4,5 mm /.177 - 7 shots magazine in cal. 5,5 mm /.22
<b>Finish</b>	Black Synthetic stock - Black anodized receiver - blued steel air cylinder	<b>Included in the box</b>	Charging connector, 1 magazine, 2 side rails, MGS kit, instruction manual, spare O-rings
<b>Total length</b>	986 mm / 39"	<b>Suggested for</b>	Small game hunting / Varmint control / Target shooting
<b>Barrel</b>	565 mm - Rifled, blued steel barrel with integrated S4 suppressor system Twist rate (mm) 1:480		





reddot winner

**STOEGER AIRGUNS XM1  
S4 SUPPRESSOR WON THE RED DOT AWARD  
PRODUCT DESIGN**

The "Red Dot" is the award for high design quality. The international jury only awards this sought-after seal of quality to products that feature an outstanding design.

**STATEMENT BY THE JURY**

The highly dynamic and modern design of the XM1 S4 Suppressor air rifle presents a functionality that was composed with ergonomic requirements in mind.



4,5 mm/.177: 280 m/s - 920 fps 5,5 mm/.22: 220 m/s - 720 fps

## XM1 S4 SUPPRESSOR

All innovative XM1 features plus the new generation of integral silencer S4 cumulating baffles and compensators.



XM1 S4 SUPPRESSOR

XM1 S4 SUPPRESSOR - COMBO

### INCLUDED WITH THE RIFLE

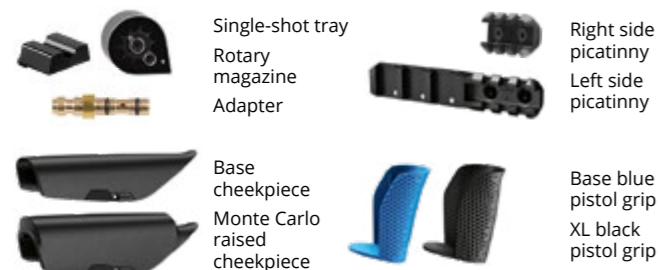

**PRO ADAPTIVE LENGTH**  
Length of pull adjustable with color spacers for optimal comfort



**ERGONOMIC BOLT LEVER**  
With exclusive THRIDION checkering for maximum grip



**LEFT SIDE PICATINNY RAIL**  
Multi-use Picatinny rail integrating a rack for 3 spare magazines



**PRO ADAPTIVE TRIGGER**  
Progressive regulation of the trigger length (-4 mm +8 mm)

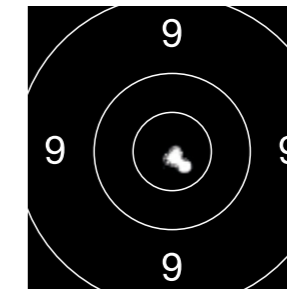

**HIGH PRECISION**  
XM1 PCP rifle can perform the best accuracy in its category with a 5 shot group



**PRO SERVICING**  
Removable silencer cover for easy access to the pressure gauge

### XM1 S4 SUPPRESSOR - TECHNICAL FEATURES

<b>Caliber</b>	4,5 mm /.177 - 5,5 mm /.22	<b>Weight (+/- 0,1)</b>	2,6 Kg
<b>Power source</b>	Precharged pneumatic (PCP) with integrated regulator	<b>Velocity cal. 4,5 mm (+/- 2%) 0,69 g pellet</b>	Up to 280 m/s - 920 fps
<b>Cocking system</b>	Bolt Action	<b>Velocity cal. 5,5 mm (+/- 2%) 1,37 g pellet</b>	Up to 220 m/s - 720 fps
<b>Trigger System</b>	Single stage trigger - Adjustable slide trigger (-4mm/+8mm)	<b>Max energy delivered (+/- 2%)</b>	Cal. 4,5 mm / .177: 27J - Cal. 5,5 mm / .22: 34J
<b>Safety</b>	Manual on trigger guard	<b>Cylinder Pressure</b>	200 BAR / 2900 PSI fill pressure / Integrated pressure gauge
<b>Sight / Scope Rail</b>	Adjustable sight - 11 mm dovetail	<b>Cylinder Size</b>	100cc
<b>Stock</b>	Human Tech Design Synt. Stock - Ergonomic Features - MGS Technology Ambidextrous Stock Design - 2 interchangeable combs	<b>Rotary magazine</b>	9 shots magazine in cal. 4,5 mm /.177 - 7 shots magazine in cal. 5,5 mm /.22
<b>Finish</b>	Black Synthetic stock - Black anodized receiver - blued steel air cylinder	<b>Included in the box</b>	Charging connector, 1 magazine, 2 side rails, MGS kit, instruction manual, spare O-rings
<b>Total length</b>	1146 mm / 45"	<b>Suggested for</b>	Small game hunting / Varmint control / Target shooting
<b>Barrel</b>	565 mm - Rifled, blued steel barrel with integrated S4 suppressor system Twist rate (mm) 1:480		

# SILENCE REVOLUTION



## PATENTED S4 SUPPRESSOR

The new Patented\* S4 SUPPRESSOR is the latest Stoeger AIRGUNS design evolution of the integral silencer system, combines the DUAL-EFFECT of the **baffles** and **decompression chamber** and now the additional **compensator** technology.

The new XM1 incorporates the most advanced technology to reduce the noise better than ever.  
**The best in its class.**

\*EP3023729 \*US10514224 \*ZL201580063122.8



red dot winner



4,5 mm/.177: 280 m/s - 920 fps 5,5 mm/.22: 220 m/s - 720 fps

## XM1 SPORT

The all-new XM1 SPORT rifles feature important technical solutions, technologies, and two improvements in order to meet the shooters who like to compete in amateur competitions and hit a new niche of market for the brand. The Main features are the new Match Trigger that allows the end user to regulate the trigger, the new Muzzle Brake that allows the rifles to be more accurate reducing the turbulence on the pellets fired, the iconic XM1 Design, and the ergonomics of the rifles, the modularity thanks to the Stoeger AIRGUNS MGS Technology.



## INCLUDED WITH THE RIFLE

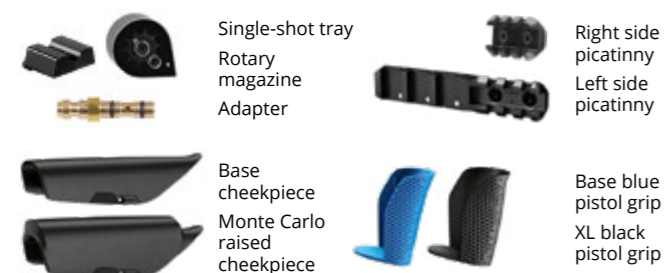

**PRO ADAPTIVE LENGTH**  
Length of pull adjustable with color spacers for optimal comfort



**ERGONOMIC BOLT LEVER**  
With exclusive THRIDION checkering for maximum grip



**LEFT SIDE PICATINNY RAIL**  
Multi-use Picatinny rail integrating a rack for 3 spare magazines



**MATCH TRIGGER**  
Adjustable trigger on 3 axis (X/Y/Z)

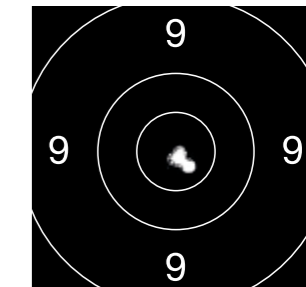

**HIGH PRECISION**  
XM1 PCP rifle can perform the best accuracy in its category with a 5 shot group

## XM1 SPORT - TECHNICAL FEATURES

<b>Caliber</b>	4,5 mm /.177 - 5,5 mm /.22	<b>Weight (+/- 0,1)</b>	2,5 Kg
<b>Power source</b>	Precharged pneumatic (PCP) with integrated regulator	<b>Velocity cal. 4,5 mm (+/- 2%) 0,69 g pellet</b>	Up to 280 m/s - 920 fps
<b>Cocking system</b>	Bolt Action	<b>Velocity cal. 5,5 mm (+/- 2%) 1,37 g pellet</b>	Up to 220 m/s - 720 fps
<b>Trigger System</b>	Single stage trigger - Adjustable 3 Axis trigger (X/Y/Z)	<b>Max energy delivered (+/- 2%)</b>	Cal. 4,5 mm /.177: 27J - Cal. 5,5 mm /.22: 34J
<b>Safety</b>	Manual on trigger guard	<b>Cylinder Pressure</b>	200 BAR / 2900 PSI fill pressure / Integrated pressure gauge
<b>Sight / Scope Rail</b>	No sight - 11 mm dovetail	<b>Cylinder Size</b>	100cc
<b>Stock</b>	Human Tech Design Synt. Stock - Ergonomic Features - MGS Technology Ambidextrous Stock Design - 2 interchangeable combs	<b>Rotary magazine</b>	9 shots magazine in cal. 4,5 mm /.177 - 7 shots magazine in cal. 5,5 mm /.22
<b>Finish</b>	Black Synthetic stock - Black anodized receiver - blued steel air cylinder	<b>Included in the box</b>	Charging connector, 1 magazine, 2 side rails, MGS kit, instruction manual, spare O-rings
<b>Total length</b>	<b>Sport</b> 1019 mm / 40.2" - <b>Sport Suppressor</b> 1090 mm / 42.9"	<b>Suggested for</b>	Small game hunting / Varmint control / Target shooting
<b>Barrel</b>	500 mm -Free floating - Rifled, blued steel barrel - Muzzle brake Twist rate (mm) 1:480		

# RX LINE



**RX**

**THE  
RELENTLESS  
ADVENTURER**

RX3TAC

Human  
Tech Design

STG21105448

 **Stoeger** AIRGUNS

 **BERETTA**  
HOLDING



- 01 Comfort rear pad**  
To provide the best comfort and stability to the shooter
- 02 Greatest ergonomics stock ever**
- 03 Cheekpiece Setting 3 STEPS:**  
Min flush surface  
Med + 10mm  
Max + 20mm

- 04 The quick adjustable cheekpiece**  
Is a unique design specifically made for the RX20TAC by Italian engineers
- 05 Safe**  
With comfortable grip  
Pro Adaptive Checkering
- 06 Optimized for control and comfort**  
For a perfect ergonomics and comfort

- 07 Pro Adaptive length**  
Length of pull adjustable with color spacers for optimal comfort
- 08 Improved ergonomics**  
The advanced stock design provide multiple grip and shooting position
- 09 Interchangeable pistol grip**  
Base black pistol grip checkering level 1  
Blue/orange pistol grip rougher embossing finish

- 10 Interchangeable Pads**  
Base black Pad checkering level 1  
Blue/orange Pads rougher embossing finish
- 11 Picatinny rail**  
For bipod
- 12 Tactical precision stock**  
And barrel design

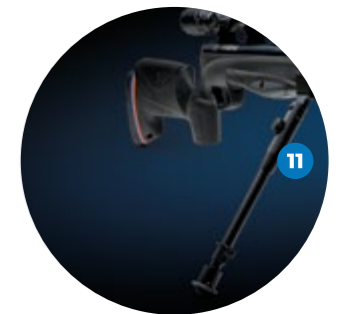

# RX20TAC



4,5 mm/.177: 305 m/s - 1000 fps 5,5 mm/.22: 240 m/s - 800 fps

## RX20TAC

The RX20TAC is Stoeger AIRGUNS first Varmint rifle. It's carefully engineered for best shooting comfort and innovative style that allows exclusive fit and customization: T2 double stage trigger group; 3-9x40 AO scope and high power 2 ring mount; Picatinny side rails for bipod and accessories. Designed for dynamic shooters.



**RX20TAC - BARREL**  
RX20TAC has identical external style to RX20TAC S2 SUPPRESSOR but without internal Suppressor technology. **RX20TAC longer barrel +95 mm extends to the muzzle.**

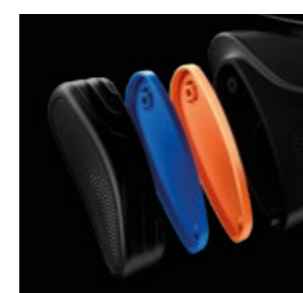

**PRO ADAPTIVE LENGTH**  
Length of pull adjustable with color spacers for optimal comfort



**SAFETY BUTTON**  
With Pro Adaptive Checkering



**ADJUSTABLE TRIGGER**  
Adjustable T2 double stage trigger



**MGS CHEEKPIECE**  
Adjustable cheekpiece in 3 steps, from 0 to 20mm



**MULTI GRIP SYSTEM**  
Black Pro Adaptive Checkering  
Blue embossed  
Orange embossed



**PISTOL GRIP/PADS**  
Included with the rifle

## RX20TAC - TECHNICAL FEATURES

<b>Caliber</b>	4,5 mm /.177 - 5,5 mm /.22	<b>Scope for combo</b>	3-9x40 AO scope with high power mount
<b>Power source</b>	Spring or Gas Ram and Piston	<b>Total length</b>	44 in. / 1.122 mm
<b>Cocking system</b>	Break-action breech-loader with ergonomic cocking grip	<b>Barrel length</b>	18 in. / 461,8 mm
<b>Trigger</b>	Stoeger AIRGUNS Adjustable trigger T2 - double stage	<b>Weight</b>	3 Kg without scope
<b>Safety</b>	Automatic, ambidextrous safety mounted on back of receiver	<b>LOP</b>	Max 370 mm - Medium 363 mm - Low 356 mm
<b>Stock</b>	Human Tech Design Stock with Pro Adaptive Checkering and Multi Grip System MGS	<b>Velocity cal. 4,5 mm with alloy pellet</b>	360 m/s - 1200 fps
<b>Finish</b>	Black Synthetic - Rifled, blued steel barrel	<b>Velocity cal. 4,5 mm with lead pellet</b>	305 m/s - 1000 fps
<b>Rail for scope</b>	Integral dovetail scope rail on receiver	<b>Velocity cal. 5,5 mm with lead pellet</b>	240 m/s - 800 fps





4,5 mm/.177: 200 m/s - 660 fps 5,5 mm/.22: 150 m/s - 500 fps

## RX5TAC - COMPACT FOR EVERY SHOOTER

Engineered for the whole family, the compact design with the industry leading RXTAC comfort adjustable stock is specifically tailored to the shooter needs and usability scenario. Double stage trigger, adjustable cheekpiece and pull length, extremely performant without compromise on power, comfort, quality, fun.



RX5TAC

RX5TAC - COMBO



**PRO ADAPTIVE LENGTH**  
Length of pull adjustable with color spacers for optimal comfort



**SAFETY BUTTON**  
With Pro Adaptive Checkering



**MGS CHEEKPIECE**  
Adjustable cheekpiece in 3 steps, from 0 to 20mm



**MULTI GRIP SYSTEM**  
Black Pro Adaptive Checkering  
Blue embossed  
Orange embossed



**PISTOL GRIP/PADS**  
Included with the rifle

## RX5TAC - TECHNICAL FEATURES

<b>Caliber</b>	4,5 mm /.177 - 5,5 mm /.22	<b>Rail for scope</b>	Integral dovetail scope rail on receiver
<b>Power source</b>	Spring Piston	<b>Scope for combo</b>	4x32 with two rings
<b>Cocking system</b>	Break-action breech-loader with ergonomic cocking grip	<b>Total length</b>	41 in. / 1.030 mm
<b>Trigger</b>	Double stage - factory set	<b>Barrel length</b>	16.5 in. / 420 mm
<b>Safety</b>	Automatic, ambidextrous safety mounted on back of receiver	<b>Weight</b>	2,4 Kg without scope
<b>Front sight</b>	Hooded front sight with a red, fiber-optic insert	<b>LOP</b>	Max 370 mm - Medium 363 mm - Low 356 mm
<b>Rear sight</b>	Fiber-optic, fully adjustable for elevation and windage	<b>Velocity cal. 4,5 mm with alloy pellet</b>	245 m/s - 810 fps
<b>Stock</b>	Human Tech Design Stock with Pro Adaptive Checkering and Multi Grip System MGS	<b>Velocity cal. 4,5 mm with lead pellet</b>	200 m/s - 660 fps
<b>Finish</b>	Black Synthetic - Rifled, blued steel barrel	<b>Velocity cal. 5,5 mm with lead pellet</b>	150 m/s - 500 fps

4,5 mm/.177: 140 m/s - 450 fps

## RX3TAC - FOR YOUNG ADVENTURERS

RX3TAC is the most flexible rifle for kids. Without compromise, best comfort with double stage trigger, automatic safety, adjustable cheekpiece and pull length, adjustable open sights with fiber optic, rail for scope and Picatinny rails for accessories.



RX3TAC

RX3TAC - COMBO



**PRO ADAPTIVE LENGTH**  
Length of pull adjustable with color spacers for optimal comfort



**SAFETY BUTTON**  
With Pro Adaptive Checkering



**MGS CHEEKPIECE**  
Adjustable cheekpiece in 3 steps, from 0 to 20mm



**MULTI GRIP SYSTEM**  
Black Pro Adaptive Checkering pads  
Blue embossed pads  
Orange embossed pads



**PADS**  
Included with the rifle

## RX3TAC - TECHNICAL FEATURES

<b>Caliber</b>	4,5 mm /.177	<b>Rail for scope</b>	Integral dovetail scope rail on receiver
<b>Power source</b>	Spring Piston	<b>Scope for combo</b>	4x32 with two rings
<b>Cocking system</b>	Break-action breech-loader with ergonomic cocking grip	<b>Total length</b>	35.4 in. / 900 mm
<b>Trigger</b>	Double stage - factory set	<b>Barrel length</b>	14.5 in. / 370 mm
<b>Safety</b>	Automatic, ambidextrous safety mounted on back of receiver	<b>Weight</b>	2,1 Kg without scope
<b>Front sight</b>	Hooded front sight with a red, fiber-optic insert	<b>LOP</b>	Max 370 mm - Medium 363 mm - Low 356 mm
<b>Rear sight</b>	Fiber-optic, fully adjustable for elevation and windage	<b>Velocity cal. 4,5 mm with alloy pellet</b>	170 m/s - 560 fps
<b>Stock</b>	Human Tech Design Stock with Pro Adaptive Checkering and Multi Grip System MGS	<b>Velocity cal. 4,5 mm with lead pellet</b>	140 m/s - 450 fps
<b>Finish</b>	Black Synthetic - Rifled, blued steel barrel		

# RX40



4,5 mm/.177: 305 m/s - 1000 fps 5,5 mm/.22: 240 m/s - 800 fps

## RX40 - SINGULAR PERSONALITY

Smart and designed to place leisure and fun at the heart of the precision shooting experience. The RX40 rifle has been designed for those who seek the utmost style and comfort. Great ergonomics of the stock and easy under lever cocking.

## PRECISION AND POWER

- Fixed barrel single shot for optimal precision
- Barrel and cylinder a solidly assembled in one strong unit
- Flip-up magazine



RX40

RX40 - COMBO



**SAFETY BUTTON**  
With Pro Adaptive Checkering



**FLIP-UP MAGAZINE**



**RECOIL ABSORBING PAD**  
with Pro Adaptive anti slip checkering



**ADJUSTABLE TRIGGER**  
Adjustable T2 double stage trigger



**FIBER OPTIC FRONT SIGHT**  
Release button Underlever cocking



**MULTI GRIP SYSTEM**  
(only on Synthetic finish rifles) Black Pro Adaptive Checkering pads, Blue embossed pads, Orange embossed pads



*\*The RX Hardwood finish rifles do not feature the MGS technology and do not include the interchangeable pads*

## RX40 - TECHNICAL FEATURES

<b>Caliber</b>	4,5 mm /.177 - 5,5 mm /.22	<b>Rail for scope</b>	Integral dovetail scope rail on receiver
<b>Power source</b>	Spring or Gas Ram and Piston	<b>Scope for combo</b>	3-9x40 AO with high power mount
<b>Cocking system</b>	Under lever cocking - Fixed barrel single shot for optimal precision	<b>Total length</b>	43 in. / 1.090 mm
<b>Trigger</b>	Stoeger AIRGUNS Adjustable trigger T2 - double stage	<b>Barrel length</b>	16.5 in. / 420 mm
<b>Safety</b>	Automatic, ambidextrous safety mounted on back of receiver	<b>Weight</b>	3 Kg without scope
<b>Front sight</b>	Hooded front sight with a red fiber-optic	<b>Velocity cal. 4,5 mm with alloy pellet</b>	360 m/s - 1200 fps
<b>Rear sight</b>	Fiber-optic, fully adjustable for elevation and windage	<b>Velocity cal. 4,5 mm with lead pellet</b>	305 m/s - 1000 fps
<b>Stock</b>	Human Tech Design Stock with Pro Adaptive Checkering and Multi Grip System MGS	<b>Velocity cal.5,5 mm with lead pellet</b>	240 m/s - 800 fps
<b>Finish</b>	Black Synthetic   Green Synthetic   Grey Synthetic   Hardwood - Rifled, blued steel barrel		



# THE EVOLUTION OF SILENCE

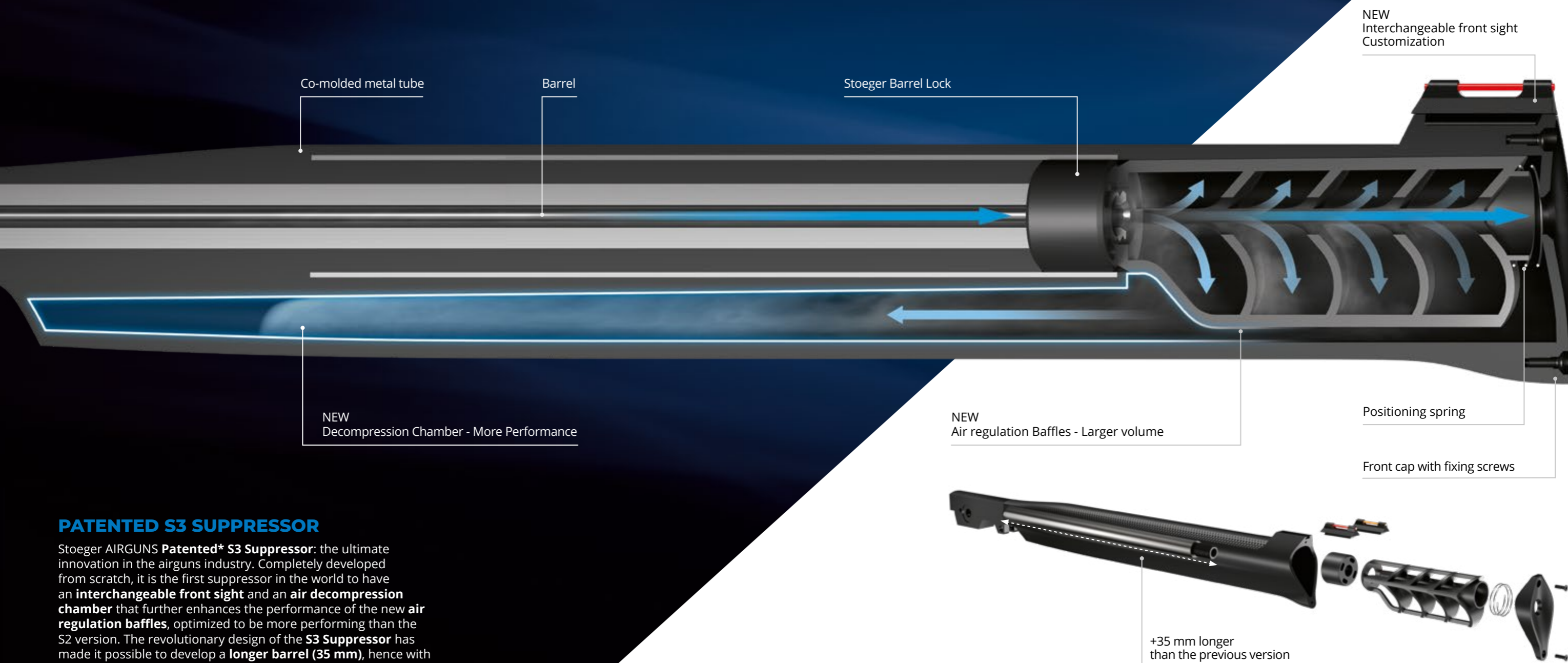

## PATENTED S3 SUPPRESSOR

Stoeger AIRGUNS **Patented\* S3 Suppressor**: the ultimate innovation in the airguns industry. Completely developed from scratch, it is the first suppressor in the world to have an **interchangeable front sight** and an **air decompression chamber** that further enhances the performance of the new **air regulation baffles**, optimized to be more performing than the S2 version. The revolutionary design of the **S3 Suppressor** has made it possible to develop a **longer barrel (35 mm)**, hence with a greater precision of shooting.

Innovation, Technology and Style are the three principles behind our "Human Tech Design" philosophy. The Stoeger AIRGUNS RX20 S3 incorporates the very best in style and performance. The S3 Suppressor System combines the functions of an internal air regulation baffles and the new decompression chamber, that work in tandem to reduce noise better than any other airguns on the market.

\*EP3023729 \*US10514224 \*ZL201580063122.8

**S3**  
SUPPRESSOR

 **Stoeger** AIRGUNS

 **BERETTA**  
HOLDING

4,5 mm/.177: 305 m/s - 1000 fps 5,5 mm/.22: 240 m/s - 800 fps

## RX20 - PERFECT FEELING

Innovation, Technology and Style are the three principles behind a fully new concept. Stoeger AIRGUNS designer's challenge has been to develop and implement something special that could convey new emotions. The unique design and ergonomic shapes makes the air rifle fit perfectly to the shooter.



**RX20 SPORT - BARREL**  
RX20 SPORT has identical external style to RX20 S3 SUPPRESSOR but without internal Suppressor technology.  
**RX20 SPORT longer barrel +95 mm extends to the muzzle.**



**RECOIL ABSORBING PAD**  
with Pro Adaptive anti slip checkering



**SAFETY BUTTON**  
With Pro Adaptive Checkering



**ADJUSTABLE TRIGGER**  
Adjustable T2 double stage trigger



**INTERCHANGEABLE FRONT SIGHT**  
(S3 Suppressor - Sport) with red and orange fiber optic



**MULTI GRIP SYSTEM**  
(only on Synthetic finish rifles) Black Pro Adaptive Checkering pads, Blue embossed pads, Orange embossed pads



*\*The RX Hardwood finish rifles do not feature the MGS technology and do not include the interchangeable pads*

## RX20 S3 SUPPRESSOR / RX20 SPORT / RX20 DYNAMIC - TECHNICAL FEATURES

<b>Caliber</b>	4,5 mm /.177 - 5,5 mm /.22	<b>Rail for scope</b>	Integral dovetail scope rail on receiver
<b>Power source</b>	Spring or Gas Ram and Piston	<b>Scope for combo</b>	4x32 with two rings
<b>Cocking system</b>	Break-action breech-loader with ergonomic cocking grip	<b>Total length</b>	<b>S3 Suppressor / Sport:</b> 44 in. / 1.122 mm - <b>Dynamic:</b> 42.5 in. / 1.080 mm
<b>Trigger</b>	Stoeger AIRGUNS Adjustable trigger T2 - double stage	<b>Barrel length</b>	<b>S3 Suppressor:</b> 14 in./366,7 mm - <b>Sport:</b> 18 in./461,8 mm - <b>Dynamic:</b> 16.5 in./419,7 mm
<b>Safety</b>	Automatic, ambidextrous safety mounted on back of receiver	<b>Weight</b>	3 Kg without scope
<b>Front sight</b>	Interchangeable front sight (S3 Suppressor, Sport) Hooded front sight with a red and orange, fiber-optic	<b>Velocity cal. 4,5 mm with alloy pellet</b>	360 m/s - 1200 fps
<b>Rear sight</b>	Fiber-optic, fully adjustable for elevation and windage	<b>Velocity cal. 4,5 mm with lead pellet</b>	305 m/s - 1000 fps
<b>Stock</b>	Human Tech Design Stock with Pro Adaptive Checkering and Multi Grip System MGS	<b>Velocity cal.5,5 mm with lead pellet</b>	240 m/s - 800 fps
<b>Finish</b>	Black Synthetic   Green Synthetic   Grey Synthetic   Hardwood - Rifled, blued steel barrel		

4,5 mm/.177: 200 m/s - 660 fps 5,5 mm/.22: 150 m/s - 500 fps

## RX5 - COMPACT PERFORMANCE

Human Tech Design philosophy translated to a compact and light, easy to handle air rifle with RX aesthetics and functional innovations – to approach the world of air rifles and fun outdoor shooting.



RX5

RX5 - COMBO



RECOIL ABSORBING PAD  
with Pro Adaptive  
anti slip checkering

SAFETY BUTTON  
With Pro Adaptive Checkering

FRONT SIGHT  
With fiber optic

## RX5 - TECHNICAL FEATURES

Caliber	4,5 mm /.177 - 5,5 mm /.22	Rail for scope	Integral dovetail scope rail on receiver
Power source	Spring piston	Scope for combo	4x32 with two rings
Cocking system	Break-action breech-loader with ergonomic cocking grip	Total length	41 in. / 1.030 mm
Trigger	Double stage - factory set	Barrel length	16.5 in./420 mm
Safety	Automatic, ambidextrous safety mounted on back of receiver	Weight	2,4 Kg without scope
Front sight	Hooded front sight with a red, fiber-optic insert	Velocity cal. 4,5 mm with alloy pellet	245 m/s - 810 fps
Rear sight	Fiber-optic, fully adjustable for elevation and windage	Velocity cal. 4,5 mm with lead pellet	200 m/s - 660 fps
Stock	Human Tech Design Stock with Pro Adaptive Checkering	Velocity cal.5,5 mm with lead pellet	150 m/s - 500 fps
Finish	Black Synthetic   Green Synthetic   Grey Synthetic   Hardwood - Rifled, blued steel barrel		

## PELLETS

### ACCURACY TO MEET EVERY REQUIREMENT FOR AIR RIFLES

Every shooter has specific requirements for his airgun when it comes to the ammunition. Our finely classified programme with a wide range of pellet shapes and weights will satisfy every need. Accuracy is a combination of several variables, the quality of the pellets is most important. Stoeger AIRGUNS pellets are Made in Germany with high tech technology.

**OLIMPIC QUALITY**  
Made in Germany



#### PRACTICE TARGET

Lightweight accurate pellet for training and hobby shooting. Meets all underlying requirements. For universal use, at an extremely favourable price.  
Cal. 4,5mm / .177 and 5,5mm / .22



#### GREAT PENETRATION

Medium-weight, very accurate pellet for hunting and precision shooting at medium ranges. Aerodynamic design for flat trajectories and perfect penetration.  
Cal. 4,5mm / .177 and 5,5mm / .22



#### MAX SHOCK

Heavy, accurate hunting pellet for medium ranges. High impact and penetration with maximum shock effect, with blood grooves.  
Cal. 4,5mm / .177 and 5,5mm / .22



#### SUPER ACCURATE

Extremely accurate competition and training pellet for performance-oriented shooters. Tight shot groups, clean-cut bullet holes, excellent value for money.  
Cal. 4,5mm / .177 and 5,5mm / .22



#### MAX PENETRATION

Heavy, exceptionally accurate pellet for long ranges. No lead-fouling, improved drive in barrel, no contact with lead thanks to special copper coating (20% harder than comparable lead pellets). First-class aerodynamic design for high impact and penetration. Low deformation of pellet. Tight shot groups.  
Cal. 4,5mm / .177 and 5,5mm / .22



#### HIGH SHOCK, MAX IMPACT

Heavy, exceptionally accurate hunting pellet for long ranges. Advanced X-HOLLOW design with deep hollow point and best aerodynamic properties for maximum impact, high penetration and controlled deformation of pellet. Tight shot groups.  
Cal. 4,5mm / .177 and 5,5mm / .22



#### 6-PACK 4.5MM / .177 DIFFERENT PELLETS

Test all our premium pellets in your airgun and choose the most appropriate for you:

- Velocity
- Shock effect
- Penetration

X-MATCH (40 Pellets) - X-POWER (35 Pellets)  
X-MAGNUM (30 Pellets) - X-HOLLOW (30 Pellets)  
X-HUNT (40 Pellets) - X-SPORT (40 Pellets)



Stoeger AIRGUNS reserves the right to make modifications to the products shown in this catalogue at any time without prior notice. The finishings shown in this catalogue are approximate, as a printed reproduction causes inevitable colour differences.

- Art Direction
- Graphic design
- Photo shooting
- 3D visualization
- Digital post production

**Studiopieri** Web & Graphic Agency



