



Stoeger Airguns  
is a Beretta Group brand

19/02/01

# 2019 PRODUCT CATALOGUE



[www.stoegerairguns.com](http://www.stoegerairguns.com)



Stoeger AIRGUNS reserves the right to make modifications to the products shown in this catalogue at any time without prior notice. The finishings shown in this catalogue are approximate, as a printed reproduction causes inevitable colour differences.

- Art Direction  
- 3D Visualization  
- Digital post production  
Studiopieri Web & Graphic Agency



Stoeger Airguns  
is a Beretta Group brand





# PHILOSOPHY

A rifle from Stoeger AIRGUNS is exclusive, sensual, provocative and always unmistakably Italian. In fact all the Stoeger AIRGUNS models are entirely, idealized and designed in Italy. Stoeger AIRGUNS has always been the creator of dynamic and unrivaled rifles.

The new XM1 has a cutting-edge, distinct and streamlined design with multiple souls: sporty, elegant and innovative.

Stoeger AIRGUNS rifles are incomparable through their blend of:

- Fascinating design
- Supreme shooting ergonomics
- Innovative Style
- Technological capability
- Quality



# XM1

The new XM1 muscular surfaces make the rifle appear strong and self-secure. All surfaces are designed with a clear attention to ergonomic and anatomic functionality. The innovative Italian design by Stoeger AIRGUNS can immediately be recognized at first glance. The extreme proportions and the unique line of its profile make the new XM1 a real multi-use rifle.



Stoeger Airguns is a Beretta Group brand





# NATURAL ELEGANCE



## XM1

XM1 ensures the best performance in every shooting situation, thanks to the ergo/anatomical studies performed by Italian Engineers (Human Tech Design) and the best weight-stability ratio of the rifle. A distinct style of Stoeger AIRGUNS coupled with traits of a sports rifle and hunting rifle. The rifle provides to the shooter a uniquely emotional experience. With its strong personality, pure design and absolute sportiness, the new XM1 is one of a kind.



Stoeger Airguns  
is a Beretta Group brand





# USER INTERACTION STUDY



- GRIP LEVEL 1 HARD: HEXACELL
- GRIP LEVEL 2 SOFT: THRIDION
- ▲ SUPPORT VOLUME



# FUNCTIONAL ERGONOMICS



# USER EXPERIENCE



Stoeger Airguns is a Beretta Group brand





# TECHNICAL DETAILS



**MGS Multi Grip System MONTE CARLO RAISED CHEEKPIECE:**  
for scope

**MGS Multi Grip System BASE CHEEKPIECE:**  
for open sights

**PRO ADAPTIVE LENGTH**  
Length of pull adjustable with color spacers for optimal comfort



**PRO ADAPTIVE TRIGGER**  
Most flexible trigger in its category - the first to offer the progressive regulation of the trigger length [- 4 mm + 8 mm]

**MGS Multi Grip System BASE BLUE PISTOL GRIP**

**MGS Multi Grip System XL BLACK PISTOL GRIP**

ROTARY MAGAZINE

ANTI-REFLECTION ANGLE REAR SIGHT

AIR REGULATOR INTEGRATED



**THRIDION PROADAPTIVE CHECKERING ERGONOMIC BOLT LEVER**

**EBL system - EBL Ergonomic Bolt Lever** is the first lever with exclusive **THRIDION** checkering for maximum grip

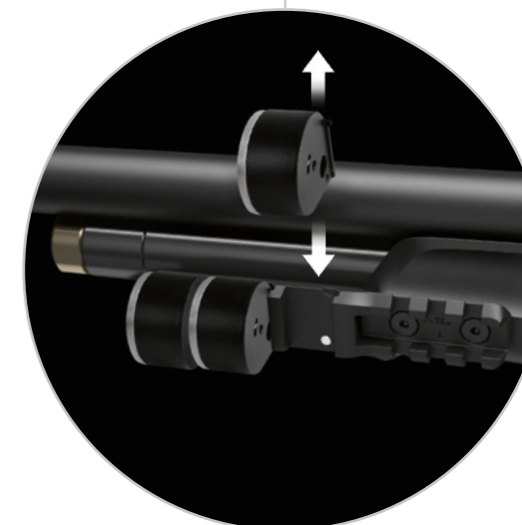

**LEFT SIDE PICATINNY RAIL WITH INTEGRATED ROTARY MAGAZINE RACK AND LOCKING MAGNETS**

The first revolutionary multi-use Picatinny rail developed by the Italian Engineers integrating a rack for 3 spare magazines



Stoeger Airguns is a Beretta Group brand





# XM1



Stoeger Airguns  
is a Beretta Group brand



***HIGH INNOVATION POWER***



320 m/s - 1050 fps

**XM1**

XM1 ensures the best performance in every shooting situation, thanks to the ergo/anatomical studies performed by Italian Engineers (Human Tech Design) and the best weight-stability ratio of the rifle.



Included with the rifle



**PRO ADAPTIVE LENGTH**  
Length of pull adjustable with color spacers for optimal comfort



**ERGONOMIC BOLT LEVER**  
With exclusive THRIDION checkering for maximum grip



**LEFT SIDE PICATINNY RAIL**  
Multi-use Picatinny rail integrating a rack for 3 spare magazines



**PICATINNY**  
Top view of the left side picatinny and the right side picatinny

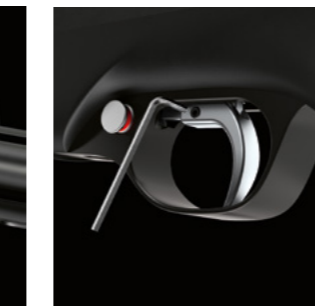

**PRO ADAPTIVE TRIGGER**  
Progressive regulation of the trigger length (-4 mm +8 mm)

**XM1 - TECHNICAL FEATURES**

<b>Caliber</b>	4,5 mm /.177 - 5,5 mm /.22	<b>Finish</b>	Black Synthetic - Rifled, blued steel barrel	<b>Cylinder size</b>	200 BAR/2900 psi fill pressure / Integrated manometer (pressure gauge)
<b>Power source</b>	Precharged pneumatic (PCP) with integrated regulator	<b>Scope for combo</b>	4x32 with high power mount	<b>Rotary magazine</b>	9 shot magazine in cal.4,5/.177 7 shot magazine in cal.5,5/.22
<b>Cocking system</b>	Bolt-action System - Repeater	<b>Total length</b>	39 in. / 986 mm	<b>Accessories included in the box</b>	Rifle, Magazine, Adapter, O-ring, MGS kit, Picatinny
<b>Trigger</b>	Stoeger Adjustable Sliding Trigger System (short position: -4 mm; long position: +8 mm)	<b>Barrel length</b>	22 in. / 565 mm	<b>Suggested for</b>	Small game hunting / target practice
<b>Safety</b>	Manual	<b>Weight</b>	2,5 Kg without scope		
<b>Front sight</b>	Interchangeable front sight with red fiber-optic	<b>Velocity cal. 4,5 mm</b>	Up to 320 m/s (1050 fps)		
<b>Rear sight</b>	Fully adjustable fiber-optic rear sight	<b>Velocity cal. 5,5 mm</b>	Up to 274 m/s (900 fps)		
<b>Stock</b>	Human Tech Design Synt. Stock - Ergonomic Features - MGS Technology - Ambidextrous Stock Design				



# SILENCE REVOLUTION



**S4** SUPPRESSOR

## PATENTED S4 SUPPRESSOR

The new Patented **S4 SUPPRESSOR** is the latest Stoeger AIRGUNS design evolution of the integral silencer system, combines the DUAL-EFFECT of the **baffles** and **decompression chamber** and now the additional **compensator** technology.

The new **XM1** incorporates the most advanced technology to reduce the noise better than ever. **The best in its class.**



320 m/s - 1050 fps

### XM1 S4 SUPPRESSOR

All innovative XM1 features plus the new generation of integral silencer S4 cumulating baffles and compensators.



XM1 S4 SUPPRESSOR

XM1 S4 SUPPRESSOR - COMBO

Included with the rifle



**PRO ADAPTIVE LENGTH**  
Length of pull adjustable with color spacers for optimal comfort



**ERGONOMIC BOLT LEVER**  
With exclusive THRIDION checkering for maximum grip



**LEFT SIDE PICATINNY RAIL**  
Multi-use Picatinny rail integrating a rack for 3 spare magazines



**PICATINNY**  
Top view of the left side picatinny and the right side picatinny



**PRO ADAPTIVE TRIGGER**  
Progressive regulation of the trigger length (-4 mm +8 mm)



**PRO SERVICING**  
Removable silencer cover for easy access to the pressure gauge

### XM1 S4 SUPPRESSOR - TECHNICAL FEATURES

<b>Caliber</b>	4,5 mm /.177 - 5,5 mm /.22	<b>Finish</b>	Black Synthetic - Rifled, blued steel barrel	<b>Cylinder size</b>	200 BAR/2900 psi fill pressure / Integrated manometer (pressure gauge)
<b>Power source</b>	Precharged pneumatic (PCP) with integrated regulator	<b>Scope for combo</b>	4x32 with high power mount	<b>Rotary magazine</b>	9 shot magazine in cal.4,5/.177 7 shot magazine in cal.5,5/.22
<b>Cocking system</b>	Bolt-action System - Repeater	<b>Total length</b>	45 in. / 1.146 mm	<b>Accessories included in the box</b>	Rifle, Magazine, Adapter, O-ring, MGS kit, Picatinny
<b>Trigger</b>	Stoeger Adjustable Sliding Trigger System (short position: -4 mm; long position: +8 mm)	<b>Barrel length</b>	28 <sup>1/2</sup> in. / 725 mm	<b>Suggested for</b>	Small game hunting / target practice
<b>Safety</b>	Manual	<b>Weight</b>	2,6 Kg without scope		
<b>Front sight</b>	Interchangeable front sight with red fiber-optic	<b>Velocity cal. 4,5 mm</b>	Up to 320 m/s (1050 fps)		
<b>Rear sight</b>	Fully adjustable fiber-optic rear sight	<b>Velocity cal. 5,5 mm</b>	Up to 274 m/s (900 fps)		
<b>Stock</b>	Human Tech Design Synt. Stock - Ergonomic Features - MGS Technology - Ambidextrous Stock Design	<b>Suppressor</b>	S4 Suppressor System		



# RX

## USER INTERACTION STUDY



- GRIP LEVEL 1
- GRIP LEVEL 2
- ▲ SUPPORT VOLUME

## FUNCTIONAL ERGONOMICS



## USER EXPERIENCE

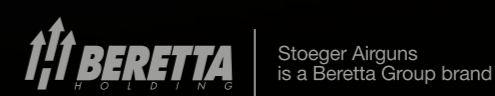



305 m/s - 1000 fps

### RX20 - PERFECT FEELING

Innovation, Technology and Style are the three principles behind a fully new concept. Stoeger AIRGUNS designer's challenge has been to develop and implement something special that could convey new emotions. The unique design and ergonomic shapes makes the air rifle fit perfectly to the shooter.

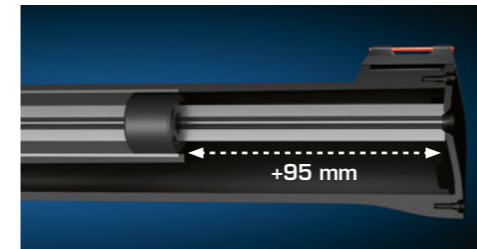

RX20 SPORT - BARREL

RX20 SPORT has identical external style to RX20 S3 SUPPRESSOR but without internal Suppressor technology. **RX20 SPORT longer barrel +95 mm extends to the muzzle.**

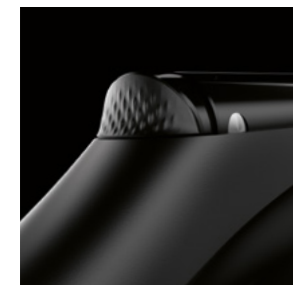

Safety Button with ProAdaptive Checkering



Recoil absorbing pad with ProAdaptive anti slip checkering



Adjustable T2 double stage trigger

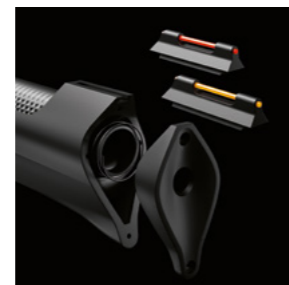

Interchangeable front sight (S3 Suppressor - Sport) with red and orange fiber optic



Multi Grip System - Black ProAdaptive Checkering Blue and Orange embossed



### RX20 S3 SUPPRESSOR / RX20 SPORT / RX20 DYNAMIC - TECHNICAL FEATURES

<b>Caliber</b>	4,5 mm / .177 - 5,5 mm / .22	<b>Finish</b>	Black Synthetic   Hardwood - Rifled, blued steel barrel
<b>Power source</b>	Spring or Gas Ram and Piston	<b>Rail for scope</b>	Integral dovetail scope rail on receiver
<b>Cocking system</b>	Break-action breech-loader with ergonomic cocking grip	<b>Scope for combo</b>	4x32 with high power mount
<b>Trigger</b>	Stoeger AIRGUNS Adjustable trigger T2 - double stage	<b>Total length</b>	<b>S3 Suppressor / Sport:</b> 44 in. / 1.122 mm - <b>Dynamic:</b> 42 <sup>1/2</sup> in. / 1.080 mm
<b>Safety</b>	Automatic, ambidextrous safety mounted on back of receiver	<b>Barrel length</b>	<b>S3 Suppressor:</b> 14 in./366,7 mm - <b>Sport:</b> 18 in./461,8 mm - <b>Dynamic:</b> 16 <sup>1/2</sup> in./419,7 mm
<b>Front sight</b>	Interchangeable front sight (S3 Suppressor, Sport) Hooded front sight with a red and orange, fiber-optic	<b>Weight</b>	3 Kg without scope
<b>Rear sight</b>	Fiber-optic, fully adjustable for elevation and windage	<b>Velocity cal.4,5 mm with alloy pellet:</b>	360 m/s - 1200 fps - <b>Velocity cal.4,5 mm with lead pellet:</b> 305 m/s - 1000 fps
<b>Stock</b>	Human Tech Design Stock with ProAdaptive Checkering and Multi Grip System MGS	<b>Velocity cal.5,5 mm with lead pellet:</b>	240 m/s - 800 fps



200 m/s - 660 fps

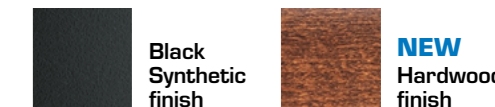

### RX5 - COMPACT PERFORMANCE

Human Tech Design philosophy translated to a compact and light, easy to handle air rifle with RX aesthetics and functional innovations – to approach the world of air rifles and fun outdoor shooting.

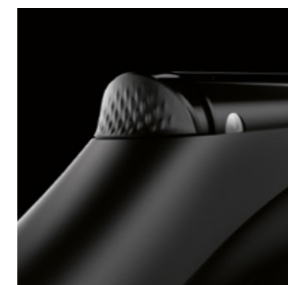

Safety Button with ProAdaptive Checkering



Recoil absorbing pad with ProAdaptive anti slip checkering



Front sight with fiber optic

### RX5 - TECHNICAL FEATURES

<b>Caliber</b>	4,5 mm /.177 - 5,5 mm /.22	<b>Finish</b>	Black Synthetic   Hardwood - Rifled, blued steel barrel
<b>Power source</b>	Spring piston	<b>Rail for scope</b>	Integral dovetail scope rail on receiver
<b>Cocking system</b>	Break-action breech-loader with ergonomic cocking grip	<b>Scope for combo</b>	4x32 with high power mount
<b>Trigger</b>	Double stage - factory set	<b>Total length</b>	41 in. / 1.030 mm
<b>Safety</b>	Automatic, ambidextrous safety mounted on back of receiver	<b>Barrel length</b>	16 <sup>1/2</sup> in./420 mm
<b>Front sight</b>	Hooded front sight with a red, fiber-optic insert	<b>Weight</b>	2,4 Kg without scope
<b>Rear sight</b>	Fiber-optic, fully adjustable for elevation and windage	<b>Velocity cal.4,5 mm with alloy pellet:</b>	245 m/s - 810 fps - <b>Velocity cal.4,5 mm with lead pellet:</b> 200 m/s - 660 fps
<b>Stock</b>	Human Tech Design Stock with ProAdaptive Checkering	<b>Velocity cal.5,5 mm with lead pellet:</b>	150 m/s - 500 fps



# F40

PRECISION POWER



**BERETTA**  
HOLDING

Stoeger Airguns  
is a Beretta Group brand

**Stoeger** AIRGUNS



# F40

305 m/s - 1000 fps



Stoeger Airguns  
is a Beretta Group brand



F40 - WOOD COMBO



F40 - WOOD

### F40 - TECHNICAL FEATURES

Caliber	4,5 mm / .177
Trigger	Adjustable double stage
Safety	Automatic
Stock	Hardwood
Optics	3-9x40 AO
Total Length	43 in. / 1090 mm
Barrel Length	16 1/2 in. / 420 mm
Weight	3,1 Kg
Velocity	Cal. 4,5 mm with alloy pellet: 360 m/s - 1200 fps Cal. 4,5 mm with lead pellet: 305 m/s - 1000 fps



### PRECISION AND POWER

- Fixed barrel single shot for optimal precision
- Barrel and cylinder a solidly assembled in one strong unit
- Flip-up magazine
- Strong air compression
- Blasting pellet at high velocity
- Automatic safety



### SINGULAR PERSONALITY

Smart and designed to place leisure and fun at the heart of the precision shooting experience. The **F40** rifle has been designed for those who seek the utmost style and comfort - ergonomics of the stock - easy under lever cocking - adjustable double stage trigger - adjustable sights with fiber optic inserts - combo version with Stoeger AIRGUNS original 3-9x40 AO scope and one piece mount.



Cocking



Loading



Closing



Safety



Recoil absorbing



Adjustable trigger



# ATAC THE TACTICAL ATTITUDE

305 m/s - 1000 fps

ATAC series are developed by Stoeger AIRGUNS in collaboration with law enforcement firearms specialists

Picatinny 3-rails for scope, bipod and accessories / 3-9x40AO scope / T2 double stage trigger group

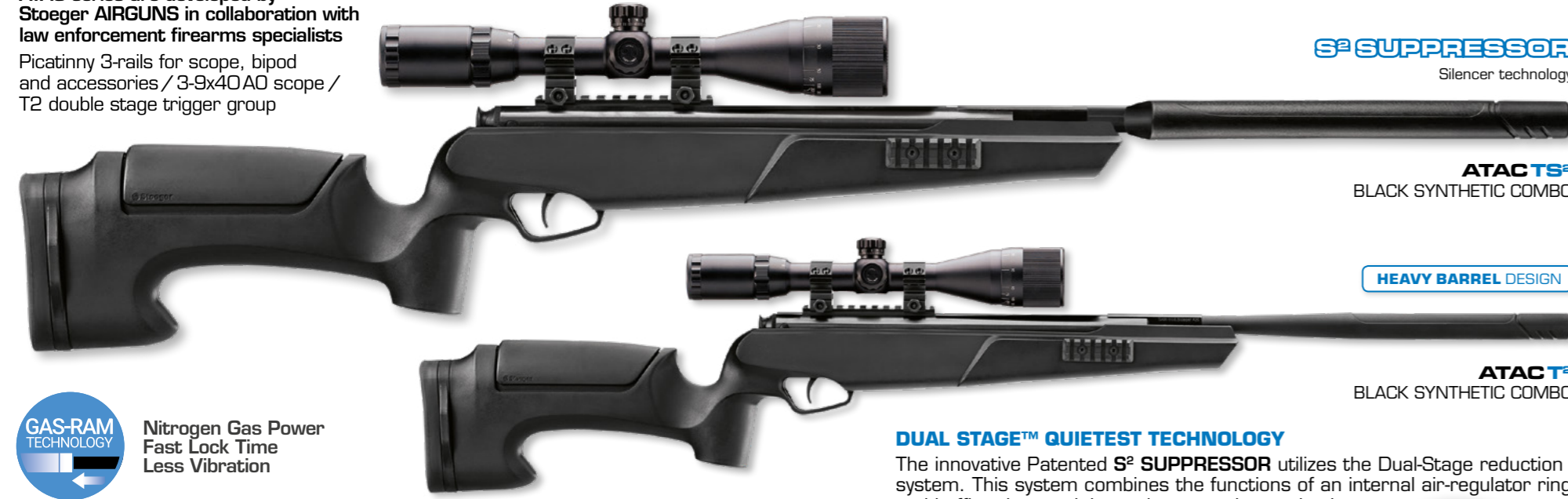

**S<sup>2</sup> SUPPRESSOR**  
Silencer technology

**ATAC TS<sup>2</sup>**  
BLACK SYNTHETIC COMBO

HEAVY BARREL DESIGN

**ATAC T<sup>2</sup>**  
BLACK SYNTHETIC COMBO



**Nitrogen Gas Power**  
Fast Lock Time  
Less Vibration



**T<sup>2</sup> Trigger Group**



### ATAC TS<sup>2</sup> / ATAC T<sup>2</sup> - TECHNICAL FEATURES

Caliber	4,5 mm / .177   5,5 mm / .22
Trigger	Adjustable double stage
Safety	Automatic
Stock	Black Synthetic
Optics	COMBO 3-9X40 AO
Total Length	43 in./1.080 mm
Barrel Length	16 1/2 in./420 mm
Weight	3,2 Kg
Velocity	Cal. 4,5 mm with alloy pellet: 360 m/s - 1200 fps Cal. 4,5 mm with lead pellet: 305 m/s - 1000 fps Cal. 5,5 mm with lead pellet: 240 m/s - 800 fps

### DUAL STAGE™ QUIETEST TECHNOLOGY

The innovative Patented **S<sup>2</sup> SUPPRESSOR** utilizes the Dual-Stage reduction system. This system combines the functions of an internal air-regulator ring and baffles that work in tandem to reduce noise better than any other air rifle on the market. Assembled on a CNC machined breach for perfect adjustment.

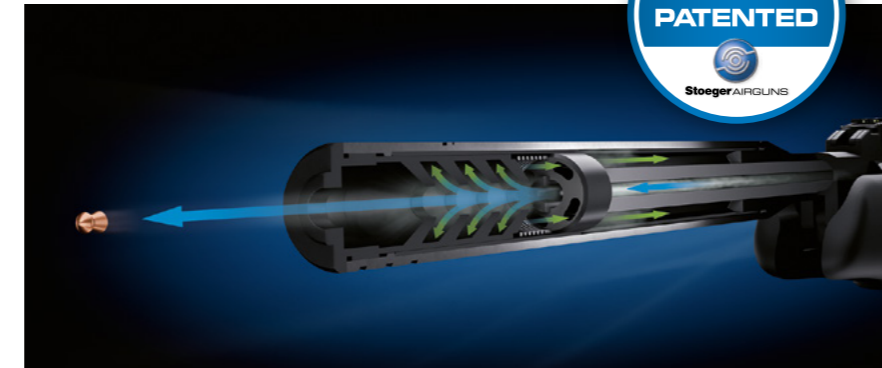

# XP4 THE TACTICAL ATTITUDE

110 m/s - 360 fps



Stoeger Airguns is a Beretta Group brand



**XP4 - BLACK SYNTHETIC**



### XP4 - TECHNICAL FEATURES

Caliber	4,5 mm / .177
Safety	Automatic
Stock	Black Synthetic
Total Length	9.7 in. / 246 mm
Barrel Length	6.7 in. / 170 mm
Weight	1,2 Kg
Velocity	Cal. 4,5 mm with alloy pellet: 130 m/s - 410 fps Cal. 4,5 mm with lead pellet: 110 m/s - 360 fps

### XP4 - THE TACTICAL ATTITUDE

The Stoeger AIRGUNS **XP4** air pistol is infused by our lineage of firearm expertise. The **XP4** lines have been conceived for an easy ambidextrous handling. Composite corrosion free frame technology for light and extremely attractive ergonomic. The **XP4** caliber 4,5mm / .177 adopts the recoilless single shot pre-compressed technology for optimal shooting comfort and accuracy. Double stage trigger. Automatic safety. Precision sights with adjustable windage and elevation rearsight and fiber optic inserts for maximum visibility. Integral slide and underneath rails for laser devices, flash lighters or other type of accessories.



Front sight with fiber optic - Slide integral mounting rail

Rail underneath the barrel

Automatic safety Double stage trigger

Adjustable rearsight with fiber optic insert





# ATAC THE MILITARY FEELING

305 m/s - 1000 fps

ATAC green series developed by Stoeger AIRGUNS in collaboration with sniper firearms specialists

Picatinny 3-rails for scope, bipod and accessories / 3-9x40 AO scope / T2 double stage trigger group



**S<sup>2</sup> SUPPRESSOR**  
Silencer technology

**ATAC TS<sup>2</sup>**  
GREEN SYNTHETIC COMBO

HEAVY BARREL DESIGN

**ATAC T<sup>2</sup>**  
GREEN SYNTHETIC COMBO



**Nitrogen Gas Power**  
Fast Lock Time  
Less Vibration



**T<sup>2</sup> Trigger Group**



### ATAC TS<sup>2</sup> / ATAC T<sup>2</sup> - TECHNICAL FEATURES

Caliber	4,5 mm / .177   5,5 mm / .22
Trigger	Adjustable double stage
Safety	Automatic
Stock	Green Synthetic
Optics	COMBO 3-9X40 AO
Total Length	43 in./1.080 mm
Barrel Length	16 1/2 in./420 mm
Weight	3,2 Kg
Velocity	Cal. 4,5 mm with alloy pellet: 360 m/s - 1200 fps Cal. 4,5 mm with lead pellet: 305 m/s - 1000 fps Cal. 5,5 mm with lead pellet: 240 m/s - 800 fps

### DUAL STAGE™ QUIETEST TECHNOLOGY

The innovative Patented **S<sup>2</sup> SUPPRESSOR** utilizes the Dual-Stage reduction system. This system combines the functions of an internal air-regulator ring and baffles that work in tandem to reduce noise better than any other air rifle on the market. Assembled on a CNC machined breach for perfect adjustment.

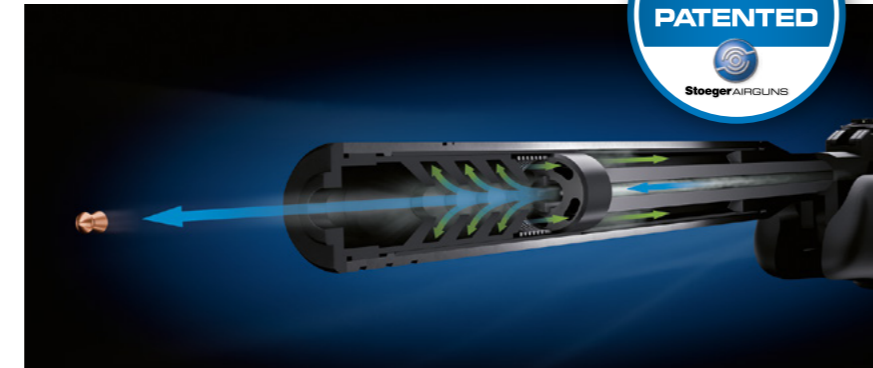

# XP4 THE MILITARY FEELING

110 m/s - 360 fps



Stoeger Airguns is a Beretta Group brand



**XP4 - GREEN SYNTHETIC**



### XP4 - THE MILITARY FEELING

The Stoeger AIRGUNS **XP4** air pistol is infused by our lineage of firearm expertise. The **XP4** lines have been conceived for an easy ambidextrous handling. Composite corrosion free frame technology for light and extremely attractive ergonomic. The **XP4** caliber 4,5mm / .177 adopts the recoilless single shot pre-compressed technology for optimal shooting comfort and accuracy. Double stage trigger. Automatic safety. Precision sights with adjustable windage and elevation rearsight and fiber optic inserts for maximum visibility. Integral slide and underneath rails for laser devices, flash lighters or other type of accessories.

### XP4 - TECHNICAL FEATURES

Caliber	4,5 mm / .177
Safety	Automatic
Stock	Green Synthetic
Total Length	9.7 in. / 246 mm
Barrel Length	6.7 in. / 170 mm
Weight	1,2 Kg
Velocity	Cal. 4,5 mm with alloy pellet: 130 m/s - 410 fps Cal. 4,5 mm with lead pellet: 110 m/s - 360 fps



Front sight with fiber optic - Slide integral mounting rail



Rail underneath the barrel



Automatic safety  
Double stage trigger



Adjustable rearsight with fiber optic insert



# X3TAC

140 m/s - 450 fps

## YOUTH - THE FUN SHOOTING EXPERIENCE

The **X3-TAC** features a skeletonized tactical-style black synthetic stock. This airgun has a short 30 cm / 11 3/4" length of pull, making it just the right size for youth.



Stoeger Airguns  
is a Beretta Group brand



### X3TAC - TECHNICAL FEATURES

Caliber	4,5 mm / .177
Trigger	Factory set double stage
Safety	Automatic
Stock	Black Synthetic
Optics	/
Total Length	35.4 in. / 900 mm
Barrel Length	14.5 in. / 370 mm
Weight	2,1 Kg
Velocity	Cal. 4,5 mm with alloy pellet: 170 m/s - 560 fps Cal. 4,5 mm with lead pellet: 140 m/s - 450 fps



X3TAC - SYNTHETIC



Pistol grip



Rear sight with fiber optic



Rubber pad



# X50

360 m/s - 1200 fps



Stoeger Airguns  
is a Beretta Group brand



X50 - SYNTHETIC COMBO

X50 - SYNTHETIC

### THE MAGNUM POWER FOR HIGH PERFORMANCE

Magnum size, high power, break barrel airgun with cocking grip, rifled precision barrel, fully adjustable rear sight with fiber optic bead, adjustable two stage trigger, automatic ambidextrous safety, ambidextrous hunting style wood, synthetic black or Camo stock, double cheek piece, checkering on pistol grip and front stock, rubber recoil pad and deeply grooved receiver that ensures a scope can be mounted securely.



X50 - WOOD COMBO

X50 - WOOD



Automatic safety



Rear sight with fiber optic



Front sight with fiber optic



Rubber pad



Adjustable trigger

X50 - TECHNICAL FEATURES	
Caliber	4,5 mm / .177   5,5 mm / .22
Trigger	Adjustable double stage
Safety	Automatic
Stock	Black Synthetic   Hardwood
Optics	3-9x40 AO
Total Length	50 in. / 1.270 mm
Barrel Length	19 1/4 in. / 490 mm
Weight	4,1 Kg
Velocity	Cal. 4,5 mm with alloy pellet: 440 m/s - 1500 fps Cal. 4,5 mm with lead pellet: 360 m/s - 1200 fps Cal. 5,5 mm with lead pellet: 280 m/s - 950 fps



FOR MAXIMAL EFFICIENCY WITH X50 MAGNUM POWER



# Accessories



Stoeger Airguns is a Beretta Group brand



3-9x40 AO scope



4x32 scope



4x32 compact scope with illuminated reticle



Target trap



Target

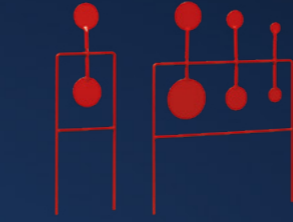

Spinning target



Soft case SAG 120 / SAG 130 - Blue



1x30 red dot



High power mount

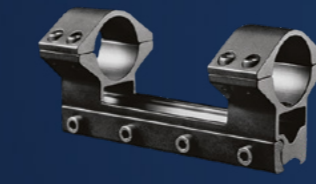

Magnum scope mount

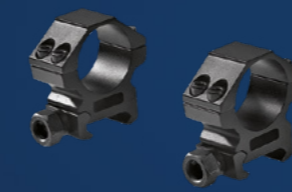

Mount for Picatinny rail

## XM1 ACCESSORIES



Hand pump



Bi-pod legs for side rail adjustable and foldable



Soft case SAG 120 / SAG 130 - Brown

## ATAC TS<sup>2</sup> - ATAC T<sup>2</sup> ACCESSORIES



High precision COMBO 3-9X40 AO scope with MIL DOT reticle



Bi-pod legs for side rail adjustable and foldable



Sling - adjustable



Butt stock spacer - can be add or removed to adjust length of pull (LOP)



Soft case SAG 120 XL with side pocket



9 shot magazine - cal. 4,5 / .177  
7 shot magazine - cal. 5,5 / .22



Right side picatinny  
Left side picatinny



Soft case SAG 120 XL / SAG 130 XL - Black



# Pellets



Stoeger Airguns is a Beretta Group brand



## ACCURACY TO MEET EVERY REQUIREMENT FOR AIR RIFLES

Every shooter has specific requirements for his airgun when it comes to the ammunition. Our finely classified programme with a wide range of pellet shapes and weights will satisfy every need. Accuracy is a combination of several variables, the quality of the pellets is most important. Stoeger AIRGUNS pellets are Made in Germany with high tech technology.

### PRACTICE TARGET

Lightweight accurate pellet for training and hobby shooting. Meets all underlying requirements. For universal use, at an extremely favourable price. Cal. 4,5mm / .177 and 5,5mm / .22



### SUPER ACCURATE

Extremely accurate competition and training pellet for performance-oriented shooters. Tight shot groups, clean-cut bullet holes, excellent value for money. Cal. 4,5mm / .177 and 5,5mm / .22



### GREAT PENETRATION

Medium-weight, very accurate pellet for hunting and precision shooting at medium ranges. Aerodynamic design for flat trajectories and perfect penetration. Cal. 4,5mm / .177 and 5,5mm / .22



### MAX PENETRATION

Heavy, exceptionally accurate pellet for long ranges. No lead-fouling, improved drive in barrel, no contact with lead thanks to special copper coating (20% harder than comparable lead pellets). First-class aerodynamic design for high impact and penetration. Low deformation of pellet. Tight shot groups. Cal. 4,5mm / .177 and 5,5mm / .22



### MAX SHOCK

Heavy, accurate hunting pellet for medium ranges. High impact and penetration with maximum shock effect, with blood grooves. Cal. 4,5mm / .177 and 5,5mm / .22



### HIGH SHOCK, MAX IMPACT

Heavy, exceptionally accurate hunting pellet for long ranges. Advanced X-HOLLOW design with deep hollow point and best aerodynamic properties for maximum impact, high penetration and controlled deformation of pellet. Tight shot groups. Cal. 4,5mm / .177 and 5,5mm / .22



### 6-PACK 4.5mm / .177 DIFFERENT PELLETS

Test all our premium pellets in your airgun and choice the most appropriate for you:

- Velocity
- Shock effect
- Penetration

X-MATCH (40 Pellets) - X-POWER (35 Pellets)  
 X-MAGNUM (30 Pellets) - X-HOLLOW (30 Pellets)  
 X-HUNT (40 Pellets) - X-SPORT (40 Pellets)