

2020 PRODUCT CATALOGUE



BERETTA
HOLDING



Stoeger AIRGUNS



OUR MISSION

Stoeger AIRGUNS mission is to offer innovative design, advanced ergonomics, fascinating models with excellent ballistic performance at the right price.

THE VISION

Our vision is permanent innovation and development of new airgun lines motivating young people to approach the world of hunting and shooting in training by handling air guns.

STOEGER AIRGUNS TODAY

Stoeger AIRGUNS is part of the prestigious BERETTA HOLDING group. It is the only brand in the group to deal exclusively with air rifles and air pistol. The headquarters of Stoeger AIRGUNS are in Italy where a team of designers and engineers are constantly working on the development of new products.



INNOVATIVE STYLE

Stoeger AIRGUNS brand is synonymous with Innovation and Italian Design. Our rifles are exclusive, sensual, provocative and always unmistakably Italian. In fact, all our models are entirely idealized and designed in Italy. Stoeger AIRGUNS has always been the creator of dynamic and unrivalled rifles.



SPORTING HEART

Stoeger AIRGUNS rifles are recreational air rifles to have fun, to enjoy the first experience of hunting and shooting. Enjoy the nature, feel good and take up a different air rifle. Our rifles are incomparable through their blend of Fascinating Design and Supreme Shooting Ergonomics.



OUR PHILOSOPHY

Stoeger AIRGUNS has always in mind the design and implementation of something special that could convey new emotions to the shooters. The Stoeger AIRGUNS brand has a cutting-edge, distinct and streamlined design with multiple souls: Sporty, Elegant and Innovative.

TECHNOLOGY



HUMAN TECH DESIGN

With its new Lines, Stoeger AIRGUNS creates the first compressed air rifles inspired by Urbino in Italy, a world heritage city, the cradle of Humanism. Stoeger AIRGUNS combines Urbino's technical inspiration with the innovative vision of Milan's designers whose experience in Industrial Design (ID) and User Experience (UX) is able to transform their technical inspirations into solid and attractive projects. Just thanks to this combination, Stoeger AIRGUNS creates a new method, based on 3 sound compact concepts: Functional Ergonomics, User Interaction Study, User Experience.



PRO ADAPTIVE CHECKERING

Stoeger AIRGUNS ProAdaptive Checkering is the first technical result of our new "Human Tech Design" philosophy. It is the most versatile, efficient and progressive checkering developed so far, one of a kind. It is the result of a project which let shooters expose themselves to a new experience, become one with the airgun and find a perfect feeling with it. The special checkering progression actively and comfortably "fits" the gun, no matter the environment shooters find themselves in.



MULTI GRIP SYSTEM

Stoeger AIRGUNS offers a shooter the choice of the favourite grip and comfort thanks to the new Multi Grip System technology which, by means of an easy and intelligent system, let the rifle be customized. Finally, shooters can adapt the rifle to their own style. Stoeger AIRGUNS rifles are incomparable through their blend of: Fascinating Design, Supreme Shooting Ergonomics, Innovative Style, Technological Capability and Quality.



RX LINE

The RX Line has been developed having in mind a new challenge: the design and implementation of something special that could convey new emotions to both the enthusiastic shooters and those who just want to have fun in the open air or at the shooting range. The RX represents the perfect match between technological style, technical efficiency and care for details. The elegant and ergonomic shapes makes the gun fit perfectly to the shooter. Stoeger AIRGUNS and its RX Line translate technology in style.



XM1

XM1 ensures the best performance in every shooting situation, thanks to the ergo/anatomical studies performed by Italian Engineers (Human Tech Design) and the best weight-stability ratio of the rifle. XM1 has a cutting-edge, distinct and streamlined design with multiple souls: sporty, elegant and innovative. A distinct style of Stoeger AIRGUNS coupled with traits of a sports rifle and hunting rifle. XM1 provides to the shooter a uniquely emotional experience. With its strong personality, pure design and absolute sportiness, XM1 is one of a kind.



BEST ACCURACY

Stoeger AIRGUNS XM1 PCP rifles high precision and best accuracy: every Stoeger AIRGUNS XM1 PCP rifle is accuracy-tested to certify your rifle can perform the best accuracy in its category with a 5 shot group. Ammunition used: Stoeger AIRGUNS X-Sport / Stoeger AIRGUNS X-Match; Distance: 10 m; Power of the rifle: Full Power; N° of shots: 5.



S3 SUPPRESSOR - PATENTED*

Completely developed from scratch, it is the first suppressor in the world to have an interchangeable front sight and an air decompression chamber that further enhances the performance of the air regulation baffles, optimized to be more performing than the S2 version. The revolutionary design of the S3 Suppressor has made it possible to develop a longer barrel (35 mm), hence with a greater precision of shooting.



S4 SUPPRESSOR - PATENTED*

The latest Stoeger AIRGUNS design evolution of the integral silencer system. It combines the Dual-Effect of the baffles and decompression chamber and now the additional compensator technology. The most advanced technology to reduce the noise better than ever. The best in its class.

XM1



 BERETTA
HOLDING

 **Stoeger AIRGUNS**

XM1

USER INTERACTION STUDY



- GRIP LEVEL 1 HARD: HEXACELL
- GRIP LEVEL 2 SOFT: THRIDIUM
- ▲ SUPPORT VOLUME

FUNCTIONAL ERGONOMICS



USER EXPERIENCE



TECHNICAL DETAILS



MGS Multi Grip System MONTE CARLO RAISED CHEEKPIECE:
for scope

MGS Multi Grip System BASE CHEEKPIECE:
for open sights

PRO ADAPTIVE LENGTH
Length of pull adjustable with color spacers for optimal comfort



PRO ADAPTIVE TRIGGER
Most flexible trigger in its category - the first to offer the progressive regulation of the trigger length [- 4 mm + 8 mm]

MGS Multi Grip System BASE BLUE PISTOL GRIP

MGS Multi Grip System XL BLACK PISTOL GRIP



ROTARY MAGAZINE

ANTI-REFLECTION ANGLE REAR SIGHT

AIR REGULATOR INTEGRATED



THRIDION PROADAPTIVE CHECKERING ERGONOMIC BOLT LEVER

EBL system - EBL Ergonomic Bolt Lever is the first lever with exclusive **THRIDION** checkering for maximum grip

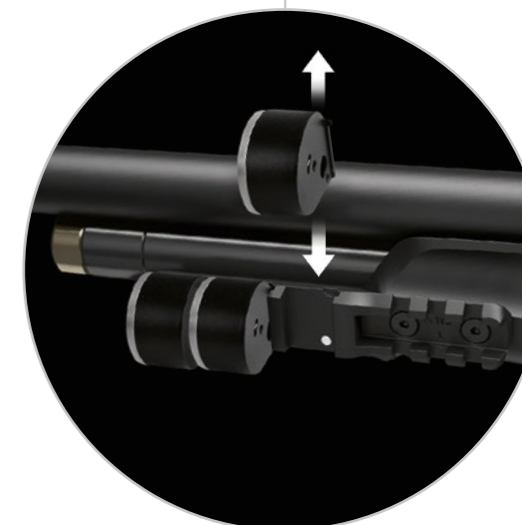

LEFT SIDE PICATINNY RAIL WITH INTEGRATED ROTARY MAGAZINE RACK AND LOCKING MAGNETS

The first revolutionary multi-use Picatinny rail developed by the Italian Engineers integrating a rack for 3 spare magazines



320 m/s - 1050 fps

XM1

XM1 ensures the best performance in every shooting situation, thanks to the ergo/anatomical studies performed by Italian Engineers (Human Tech Design) and the best weight-stability ratio of the rifle.



Included with the rifle



PRO ADAPTIVE LENGTH
Length of pull adjustable with color spacers for optimal comfort



ERGONOMIC BOLT LEVER
With exclusive THRIDION checkering for maximum grip



LEFT SIDE PICATINNY RAIL
Multi-use Picatinny rail integrating a rack for 3 spare magazines



PRO ADAPTIVE TRIGGER
Progressive regulation of the trigger length (-4 mm +8 mm)

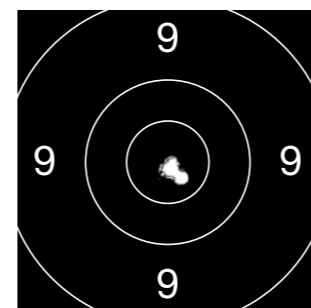

HIGH PRECISION
XM1 PCP rifle can perform the best accuracy in its category with a 5 shot group

XM1 - TECHNICAL FEATURES

Caliber	4,5 mm /.177 - 5,5 mm /.22	Finish	Black Synthetic - Rifled, blued steel barrel	Cylinder size	200 BAR/2900 psi fill pressure / Integrated manometer (pressure gauge)
Power source	Precharged pneumatic (PCP) with integrated regulator	Scope for combo	4x32 with high power mount	Rotary magazine	9 shot magazine in cal.4,5/.177 7 shot magazine in cal.5,5/.22
Cocking system	Bolt-action System - Repeater	Total length	39 in. / 986 mm	Accessories included in the box	Rifle, Magazine, Adapter, O-ring, MGS kit, Picatinny
Trigger	Stoeger Adjustable Sliding Trigger System (short position: -4 mm; long position: +8 mm)	Barrel length	22 in. / 565 mm	Suggested for	Small game hunting / target practice
Safety	Manual	Weight	2,5 Kg without scope		
Front sight	Interchangeable front sight with red fiber-optic	Velocity cal. 4,5 mm	Up to 320 m/s (1050 fps)		
Rear sight	Fully adjustable fiber-optic rear sight	Velocity cal. 5,5 mm	Up to 274 m/s (900 fps)		
Stock	Human Tech Design Synt. Stock - Ergonomic Features - MGS Technology - Ambidextrous Stock Design				

SILENCE REVOLUTION



S4 SUPPRESSOR

PATENTED S4 SUPPRESSOR

The new Patented* S4 SUPPRESSOR is the latest Stoeger AIRGUNS design evolution of the integral silencer system, combines the DUAL-EFFECT of the baffles and decompression chamber and now the additional compensator technology.

The new XM1 incorporates the most advanced technology to reduce the noise better than ever. **The best in its class.**

*EP3023729 *US10514224 *ZL201580063122.8

320 m/s - 1050 fps

XM1 S4 SUPPRESSOR

All innovative XM1 features plus the new generation of integral silencer S4 cumulating baffles and compensators.



XM1 S4 SUPPRESSOR

XM1 S4 SUPPRESSOR - COMBO

Included with the rifle



PRO ADAPTIVE LENGTH
Length of pull adjustable with color spacers for optimal comfort



ERGONOMIC BOLT LEVER
With exclusive THRIDION checkering for maximum grip



LEFT SIDE PICATINNY RAIL
Multi-use Picatinny rail integrating a rack for 3 spare magazines



PRO ADAPTIVE TRIGGER
Progressive regulation of the trigger length (-4 mm +8 mm)

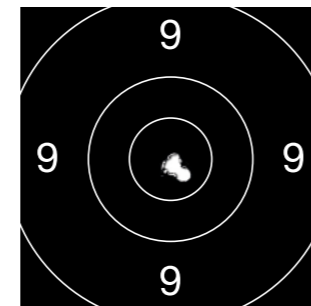

HIGH PRECISION
XM1 PCP rifle can perform the best accuracy in its category with a 5 shot group



PRO SERVICING
Removable silencer cover for easy access to the pressure gauge

XM1 S4 SUPPRESSOR - TECHNICAL FEATURES

Caliber	4,5 mm /.177 - 5,5 mm /.22	Finish	Black Synthetic - Rifled, blued steel barrel	Cylinder size	200 BAR/2900 psi fill pressure / Integrated manometer (pressure gauge)
Power source	Precharged pneumatic (PCP) with integrated regulator	Scope for combo	4x32 with high power mount	Rotary magazine	9 shot magazine in cal.4,5/.177 7 shot magazine in cal.5,5/.22
Cocking system	Bolt-action System - Repeater	Total length	45 in. / 1.146 mm	Accessories included in the box	Rifle, Magazine, Adapter, O-ring, MGS kit, Picatinny
Trigger	Stoeger Adjustable Sliding Trigger System (short position: -4 mm; long position: +8 mm)	Barrel length	28 ^{1/2} in. / 725 mm	Suggested for	Small game hunting / target practice
Safety	Manual	Weight	2,6 Kg without scope		
Front sight	Interchangeable front sight with red fiber-optic	Velocity cal. 4,5 mm	Up to 320 m/s (1050 fps)		
Rear sight	Fully adjustable fiber-optic rear sight	Velocity cal. 5,5 mm	Up to 274 m/s (900 fps)		
Stock	Human Tech Design Synt. Stock - Ergonomic Features - MGS Technology - Ambidextrous Stock Design	Suppressor	S4 Suppressor System		



RX

 BERETTA
HOLDING

 Stoeger AIRGUNS

RX

USER INTERACTION STUDY



- GRIP LEVEL 1
- GRIP LEVEL 2
- ▲ SUPPORT VOLUME

FUNCTIONAL ERGONOMICS



USER EXPERIENCE



305 m/s - 1000 fps

RX40 - SINGULAR PERSONALITY

Smart and designed to place leisure and fun at the heart of the precision shooting experience. The RX40 rifle has been designed for those who seek the utmost style and comfort. Great ergonomics of the stock and easy under lever cocking.

PRECISION AND POWER

- Fixed barrel single shot for optimal precision
- Barrel and cylinder a solidly assembled in one strong unit
- Flip-up magazine



Safety Button with ProAdaptive Checkering



Recoil absorbing pad with ProAdaptive anti slip checkering



Adjustable T2 double stage trigger



Fiber optic front sight
Release button
Underlever cocking



Multi Grip System (only on Synthetic finish rifles)
Black ProAdaptive Checkering pads
Blue embossed pads
Orange embossed pads



* The RX Hardwood finish rifles do not feature the MGS Multi Grip System technology and do not include the interchangeable pads

RX40 - TECHNICAL FEATURES

Caliber	4,5 mm / .177	Finish	Black Synthetic Hardwood - Rifled, blued steel barrel
Power source	Spring or Gas Ram and Piston	Rail for scope	Integral dovetail scope rail on receiver
Cocking system	Under lever cocking - Fixed barrel single shot for optimal precision	Scope for combo	3-9x40AO
Trigger	Stoeger AIRGUNS Adjustable trigger T2 - double stage	Total length	43 in. / 1.090 mm
Safety	Automatic, ambidextrous safety mounted on back of receiver	Barrel length	16 1/2 in. / 420 mm
Front sight	Hooded front sight with a red fiber-optic	Weight	3 Kg without scope
Rear sight	Fiber-optic, fully adjustable for elevation and windage	Velocity cal. 4,5 mm with alloy pellet:	360 m/s - 1200 fps
Stock	Human Tech Design Stock with ProAdaptive Checkering and Multi Grip System MGS	Velocity cal. 4,5 mm with lead pellet:	305 m/s - 1000 fps

PATENTED S3 SUPPRESSOR

The Evolution of Silence

Stoeger AIRGUNS Patented* S3 Suppressor: the ultimate innovation in the airguns industry. Completely developed from scratch, it is the first suppressor in the world to have an **interchangeable front sight** and an **air decompression chamber** that further enhances the performance of the new **air regulation baffles**, optimized to be more performing than the S2 version. The revolutionary design of the S3 Suppressor has made it possible to develop a **longer barrel (35 mm)**, hence with a greater precision of shooting.

Innovation, Technology and Style are the three principles behind our "Human Tech Design" philosophy. The Stoeger AIRGUNS RX20 S3 incorporates the very best in style and performance. The S3 Suppressor System combines the functions of an internal air regulation baffles and the new decompression chamber, that work in tandem to reduce noise better than any other airguns on the market.

*EP3023729 *US10514224 *ZL201580063122.8

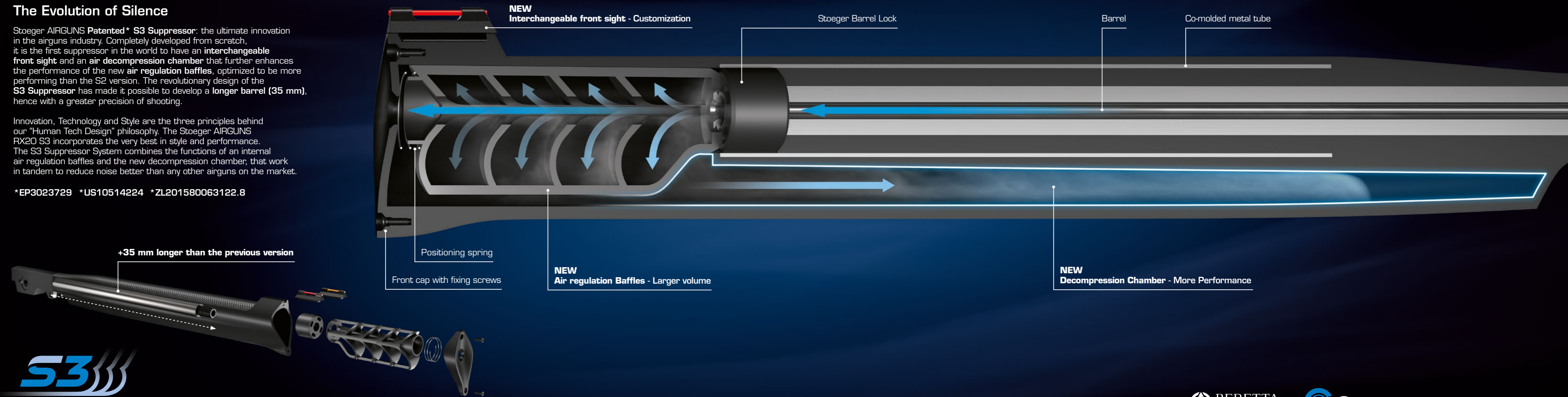

S3
SUPPRESSOR

BERETTA
HOLDING

Stoeger AIRGUNS

305 m/s - 1000 fps

RX20 - PERFECT FEELING

Innovation, Technology and Style are the three principles behind a fully new concept. Stoeger AIRGUNS designer's challenge has been to develop and implement something special that could convey new emotions. The unique design and ergonomic shapes makes the air rifle fit perfectly to the shooter.

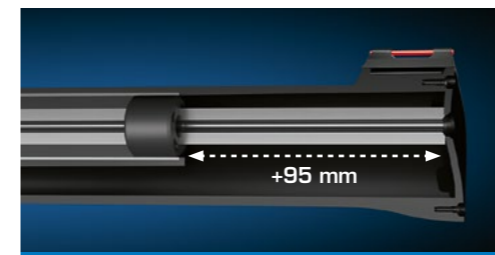

RX20 SPORT - BARREL

RX20 SPORT has identical external style to RX20 S3 SUPPRESSOR but without internal Suppressor technology. **RX20 SPORT longer barrel +95 mm extends to the muzzle.**



Safety Button with ProAdaptive Checkering



Recoil absorbing pad with ProAdaptive anti slip checkering



Adjustable T2 double stage trigger



Interchangeable front sight (S3 Suppressor - Sport) with red and orange fiber optic



Multi Grip System (only on Synthetic finish rifles) Black ProAdaptive Checkering pads Blue embossed pads Orange embossed pads



* The RX Hardwood finish rifles do not feature the MGS Multi Grip System technology and do not include the interchangeable pads

RX20 S3 SUPPRESSOR / RX20 SPORT / RX20 DYNAMIC - TECHNICAL FEATURES

Caliber	4,5 mm / .177 - 5,5 mm / .22	Finish	Black Synthetic Green Synthetic Grey Synthetic Hardwood - Rifled, blued steel barrel
Power source	Spring or Gas Ram and Piston	Rail for scope	Integral dovetail scope rail on receiver
Cocking system	Break-action breech-loader with ergonomic cocking grip	Scope for combo	4x32 with high power mount
Trigger	Stoeger AIRGUNS Adjustable trigger T2 - double stage	Total length	S3 Suppressor / Sport: 44 in. / 1.122 mm - Dynamic: 42 ^{1/2} in. / 1.080 mm
Safety	Automatic, ambidextrous safety mounted on back of receiver	Barrel length	S3 Suppressor: 14 in./366,7 mm - Sport: 18 in./461,8 mm - Dynamic: 16 ^{1/2} in./419,7 mm
Front sight	Interchangeable front sight (S3 Suppressor, Sport) Hooded front sight with a red and orange, fiber-optic	Weight	3 Kg without scope
Rear sight	Fiber-optic, fully adjustable for elevation and windage	Velocity cal.4,5 mm with alloy pellet:	360 m/s - 1200 fps - Velocity cal.4,5 mm with lead pellet: 305 m/s - 1000 fps
Stock	Human Tech Design Stock with ProAdaptive Checkering and Multi Grip System MGS	Velocity cal.5,5 mm with lead pellet:	240 m/s - 800 fps

200 m/s - 660 fps



RX5 - COMPACT PERFORMANCE

Human Tech Design philosophy translated to a compact and light, easy to handle air rifle with RX aesthetics and functional innovations – to approach the world of air rifles and fun outdoor shooting.



Safety Button with ProAdaptive Checkering



Recoil absorbing pad with ProAdaptive anti slip checkering



Front sight with fiber optic

RX5 - TECHNICAL FEATURES

Caliber	4,5 mm /.177 - 5,5 mm /.22	Finish	Black Synthetic Green Synthetic Grey Synthetic Hardwood - Rifled, blued steel barrel
Power source	Spring piston	Rail for scope	Integral dovetail scope rail on receiver
Cocking system	Break-action breech-loader with ergonomic cocking grip	Scope for combo	4x32 with high power mount
Trigger	Double stage - factory set	Total length	41 in. / 1.030 mm
Safety	Automatic, ambidextrous safety mounted on back of receiver	Barrel length	16 ¹ / ₂ in./420 mm
Front sight	Hooded front sight with a red, fiber-optic insert	Weight	2,4 Kg without scope
Rear sight	Fiber-optic, fully adjustable for elevation and windage	Velocity cal.4,5 mm with alloy pellet:	245 m/s - 810 fps - Velocity cal.4,5 mm with lead pellet: 200 m/s - 660 fps
Stock	Human Tech Design Stock with ProAdaptive Checkering	Velocity cal.5,5 mm with lead pellet:	150 m/s - 500 fps

ATAC THE TACTICAL ATTITUDE

305 m/s - 1000 fps

ATAC series are developed by Stoeger AIRGUNS in collaboration with law enforcement firearms specialists

Picatinny 3-rails for scope, bipod and accessories / 3-9x40AO scope / T2 double stage trigger group

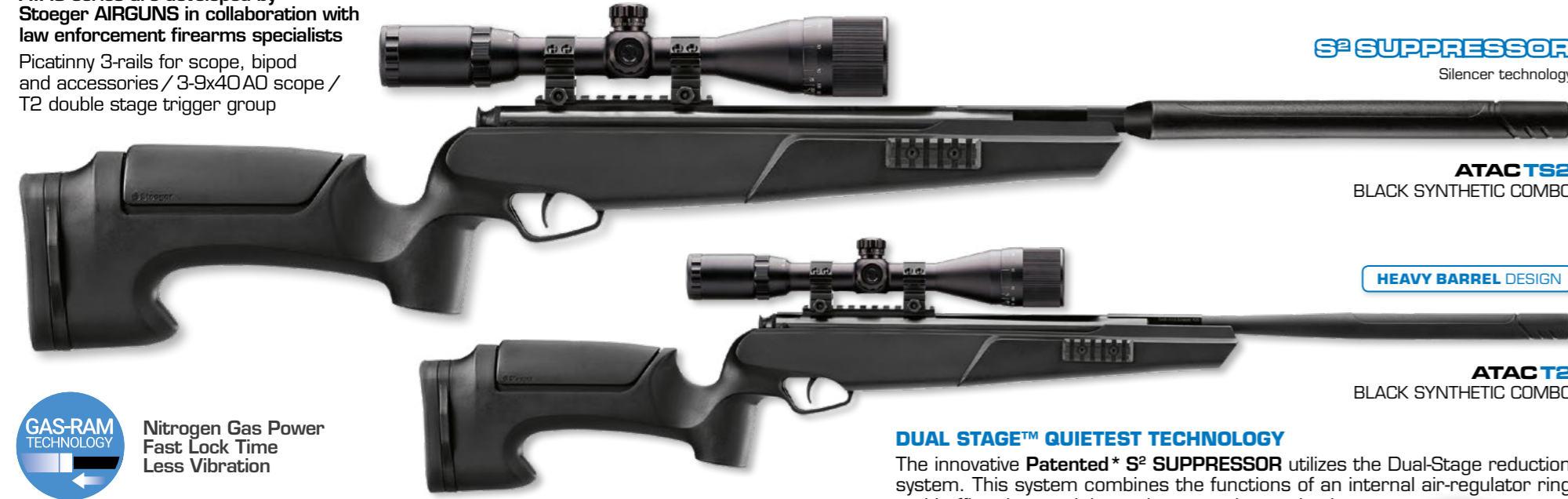

S² SUPPRESSOR
Silencer technology

ATAC TS2
BLACK SYNTHETIC COMBO

HEAVY BARREL DESIGN

ATAC T2
BLACK SYNTHETIC COMBO



Nitrogen Gas Power
Fast Lock Time
Less Vibration



T2 Trigger Group



ATAC TS2 / ATAC T2 - TECHNICAL FEATURES

Caliber	4,5 mm / .177 5,5 mm / .22
Trigger	Adjustable double stage
Safety	Automatic
Stock	Black Synthetic
Optics	COMBO 3-9X40 AO
Total Length	43 in./1.080 mm
Barrel Length	16 1/2 in./420 mm
Weight	3,2 Kg
Velocity	Cal. 4,5 mm with alloy pellet: 360 m/s - 1200 fps Cal. 4,5 mm with lead pellet: 305 m/s - 1000 fps Cal. 5,5 mm with lead pellet: 240 m/s - 800 fps

DUAL STAGE™ QUIETEST TECHNOLOGY

The innovative **Patented* S² SUPPRESSOR** utilizes the Dual-Stage reduction system. This system combines the functions of an internal air-regulator ring and baffles that work in tandem to reduce noise better than any other air rifle on the market. Assembled on a CNC machined breach for perfect adjustment.

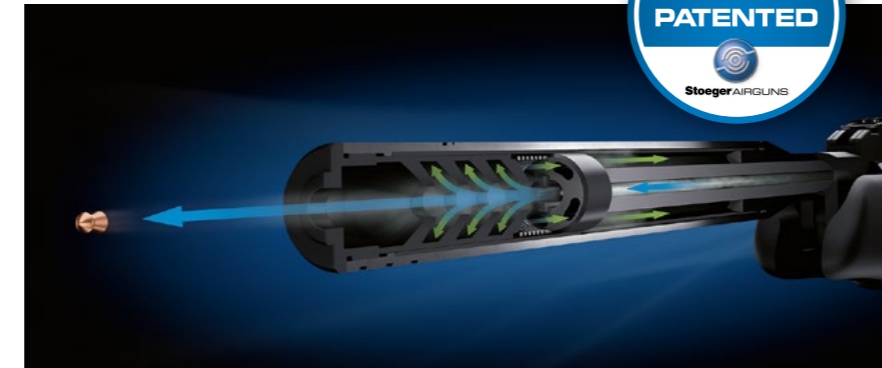

XP4 THE TACTICAL ATTITUDE

110 m/s - 360 fps



XP4 - BLACK SYNTHETIC



XP4 - THE TACTICAL ATTITUDE

The Stoeger AIRGUNS **XP4** air pistol is infused by our lineage of firearm expertise. The **XP4** lines have been conceived for an easy ambidextrous handling. Composite corrosion free frame technology for light and extremely attractive ergonomic. The **XP4** caliber 4,5mm / .177 adopts the recoilless single shot pre-compressed technology for optimal shooting comfort and accuracy. Double stage trigger. Automatic safety. Precision sights with adjustable windage and elevation rearsight and fiber optic inserts for maximum visibility. Integral slide and underneath rails for laser devices, flash lighters or other type of accessories.

XP4 - TECHNICAL FEATURES

Caliber	4,5 mm / .177
Safety	Automatic
Stock	Black Synthetic
Total Length	9.7 in. / 246 mm
Barrel Length	6.7 in. / 170 mm
Weight	1,2 Kg
Velocity	Cal. 4,5 mm with alloy pellet: 130 m/s - 410 fps Cal. 4,5 mm with lead pellet: 110 m/s - 360 fps



Front sight with fiber optic - Slide integral mounting rail



Rail underneath the barrel



Automatic safety
Double stage trigger



Adjustable rearsight with fiber optic insert

ATAC THE MILITARY FEELING

305 m/s - 1000 fps

ATAC green series developed by Stoeger AIRGUNS in collaboration with sniper firearms specialists

Picatinny 3-rails for scope, bipod and accessories / 3-9x40 AO scope / T2 double stage trigger group

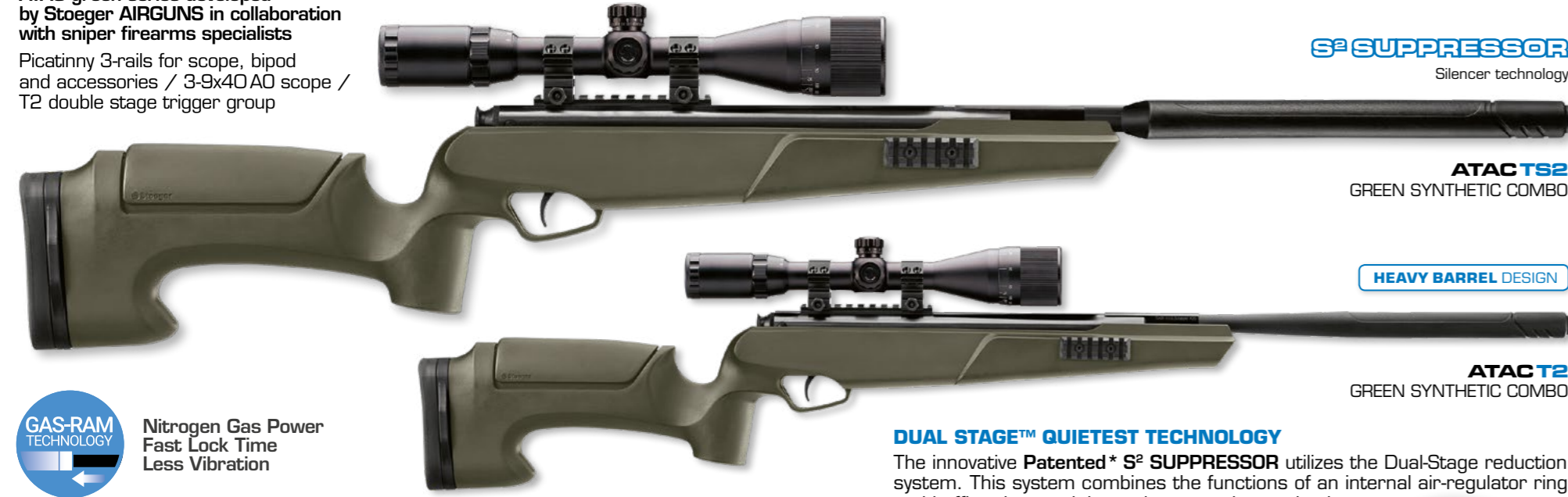

S² SUPPRESSOR
Silencer technology

ATACTS2
GREEN SYNTHETIC COMBO

HEAVY BARREL DESIGN

ATACT2
GREEN SYNTHETIC COMBO



Nitrogen Gas Power
Fast Lock Time
Less Vibration



T2 Trigger Group



ATACTS2 / ATACT2 - TECHNICAL FEATURES

Caliber	4,5 mm / .177 5,5 mm / .22
Trigger	Adjustable double stage
Safety	Automatic
Stock	Green Synthetic
Optics	COMBO 3-9X40 AO
Total Length	43 in./1.080 mm
Barrel Length	16 1/2 in./420 mm
Weight	3,2 Kg
Velocity	Cal. 4,5 mm with alloy pellet: 360 m/s - 1200 fps Cal. 4,5 mm with lead pellet: 305 m/s - 1000 fps Cal. 5,5 mm with lead pellet: 240 m/s - 800 fps

DUAL STAGE™ QUIETEST TECHNOLOGY

The innovative **Patented* S² SUPPRESSOR** utilizes the Dual-Stage reduction system. This system combines the functions of an internal air-regulator ring and baffles that work in tandem to reduce noise better than any other air rifle on the market. Assembled on a CNC machined breach for perfect adjustment.

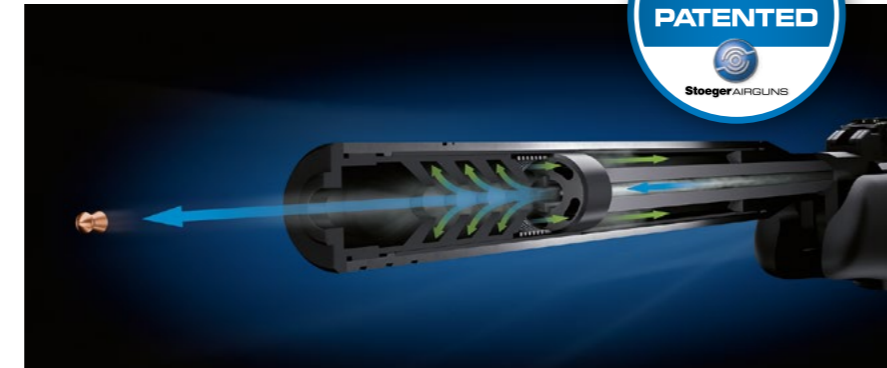

XP4 THE MILITARY FEELING

110 m/s - 360 fps

XP4 - GREEN SYNTHETIC



XP4 - THE MILITARY FEELING

The Stoeger AIRGUNS **XP4** air pistol is infused by our lineage of firearm expertise. The **XP4** lines have been conceived for an easy ambidextrous handling. Composite corrosion free frame technology for light and extremely attractive ergonomic. The **XP4** caliber 4,5mm / .177 adopts the recoilless single shot pre-compressed technology for optimal shooting comfort and accuracy. Double stage trigger. Automatic safety. Precision sights with adjustable windage and elevation rearsight and fiber optic inserts for maximum visibility. Integral slide and underneath rails for laser devices, flash lighters or other type of accessories.



Front sight with fiber optic - Slide integral mounting rail

Rail underneath the barrel

Automatic safety
Double stage trigger

Adjustable rearsight with fiber optic insert



XP4 - TECHNICAL FEATURES

Caliber	4,5 mm / .177
Safety	Automatic
Stock	Green Synthetic
Total Length	9.7 in. / 246 mm
Barrel Length	6.7 in. / 170 mm
Weight	1,2 Kg
Velocity	Cal. 4,5 mm with alloy pellet: 130 m/s - 410 fps Cal. 4,5 mm with lead pellet: 110 m/s - 360 fps



X3TAC



140 m/s - 450 fps

YOUTH - THE FUN SHOOTING EXPERIENCE

The **X3-TAC** features a skeletonized tactical-style black synthetic stock. This airgun has a short 30 cm / 11 3/4" length of pull, making it just the right size for youth.



X3 TAC - SYNTHETIC

X3TAC - TECHNICAL FEATURES

Caliber	4,5 mm / .177
Trigger	Factory set double stage
Safety	Automatic
Stock	Black Synthetic
Optics	/
Total Length	35.4 in. / 900 mm
Barrel Length	14.5 in. / 370 mm
Weight	2,1 Kg
Velocity	Cal. 4,5 mm with alloy pellet: 170 m/s - 560 fps Cal. 4,5 mm with lead pellet: 140 m/s - 450 fps



Pistol grip

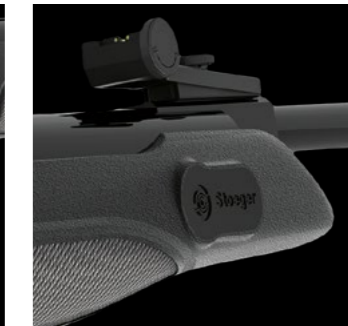

Rear sight with fiber optic



Rubber pad

Accessories



3-9x40 AO scope



4x32 scope



4x32 compact scope with illuminated reticle



1x30 red dot



High power mount

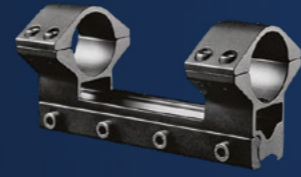

Magnum scope mount

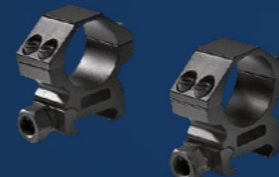

Mount for Picatinny rail

ATAC TS² - ATAC T² ACCESSORIES



High precision COMBO 3-9X40 AO scope with MIL DOT reticle



Bi-pod legs for side rail adjustable and foldable



Sling - adjustable



Butt stock spacer - can be add or removed to adjust length of pull (LOP)



Soft case SAG 120 XL with side pocket



Target trap



Target

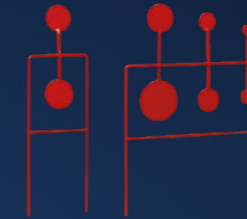

Spinning target

XM1 ACCESSORIES



Hand pump



Bi-pod legs for side rail adjustable and foldable



9 shot magazine - cal. 4,5 / .177
7 shot magazine - cal. 5,5 / .22



Right side picatinny
Left side picatinny



Soft case SAG 120 / SAG 130 - Blue



Soft case SAG 120 / SAG 130 - Brown



Soft case SAG 120 XL / SAG 130 XL - Black

ACCURACY TO MEET EVERY REQUIREMENT FOR AIR RIFLES

Every shooter has specific requirements for his airgun when it comes to the ammunition. Our finely classified programme with a wide range of pellet shapes and weights will satisfy every need. Accuracy is a combination of several variables, the quality of the pellets is most important. Stoeger AIRGUNS pellets are Made in Germany with high tech technology.

PRACTICE TARGET

Lightweight accurate pellet for training and hobby shooting. Meets all underlying requirements. For universal use, at an extremely favourable price. Cal. 4,5mm / .177 and 5,5mm / .22



SUPER ACCURATE

Extremely accurate competition and training pellet for performance-oriented shooters. Tight shot groups, clean-cut bullet holes, excellent value for money. Cal. 4,5mm / .177 and 5,5mm / .22



GREAT PENETRATION

Medium-weight, very accurate pellet for hunting and precision shooting at medium ranges. Aerodynamic design for flat trajectories and perfect penetration. Cal. 4,5mm / .177 and 5,5mm / .22



MAX PENETRATION

Heavy, exceptionally accurate pellet for long ranges. No lead-fouling, improved drive in barrel, no contact with lead thanks to special copper coating (20% harder than comparable lead pellets). First-class aerodynamic design for high impact and penetration. Low deformation of pellet. Tight shot groups. Cal. 4,5mm / .177 and 5,5mm / .22



MAX SHOCK

Heavy, accurate hunting pellet for medium ranges. High impact and penetration with maximum shock effect, with blood grooves. Cal. 4,5mm / .177 and 5,5mm / .22



HIGH SHOCK, MAX IMPACT

Heavy, exceptionally accurate hunting pellet for long ranges. Advanced X-HOLLOW design with deep hollow point and best aerodynamic properties for maximum impact, high penetration and controlled deformation of pellet. Tight shot groups. Cal. 4,5mm / .177 and 5,5mm / .22



6-PACK 4.5mm / .177 DIFFERENT PELLETS



Test all our premium pellets in your airgun and choice the most appropriate for you:

- Velocity
- Shock effect
- Penetration

X-MATCH (40 Pellets) - X-POWER (35 Pellets)
 X-MAGNUM (30 Pellets) - X-HOLLOW (30 Pellets)
 X-HUNT (40 Pellets) - X-SPORT (40 Pellets)



***FOLLOW US ON OUR
OFFICIAL SOCIAL MEDIA***

#stoegerairguns   

 **BERETTA
HOLDING**

 **StoegerAIRGUNS**

Stoeger AIRGUNS reserves the right to make modifications to the products shown in this catalogue at any time without prior notice. The finishings shown in this catalogue are approximate, as a printed reproduction causes inevitable colour differences.

- Art Direction
- Photo shooting
- 3D visualization
- Digital post production

Studiopieri Web & Graphic Agency



stoegerairguns.com

